

## FYL-25A3URC1B

### Features:

- High intensity
- General purpose leads
- RoHs compliant.

### Descriptions:

- Dice material: AlGaInP
- Emitting Color: Red
- Device Outline: 2\*5mm Square Type.
- Lens Type: water clear.

### Radiation pattern.

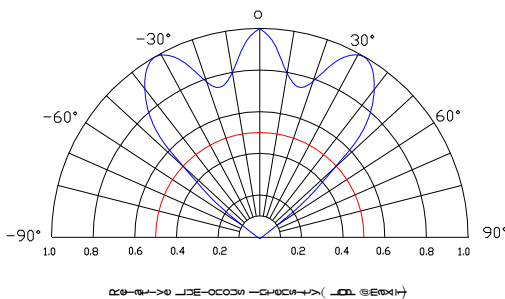

### Package configuration

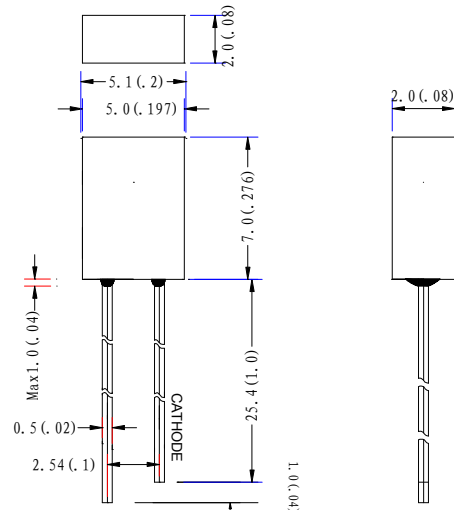

- ◆ All dimensions are millimeters (inches)
- ◆ Tolerance is  $\pm 0.25\text{mm} (.010\text{'})$  unless otherwise noted.

### Absolute maximum ratings ( $T_a = 25^\circ\text{C}$ )

Parameter	MAX.	Unit
Power Dissipation	80	mW
Peak Forward Current (1/10 Duty Cycle, 0.1ms Pulse Width)	100	mA
Continuous Forward Current	30	mA
Derating Linear From $50^\circ\text{C}$	0.4	mA/ $^\circ\text{C}$
Reverse Voltage	5	V
Operating Temperature Range	30 <del>0</del> $^\circ\text{C}$ to 80 $^\circ\text{C}$	
Storage Temperature Range	40 <del>0</del> $^\circ\text{C}$ to 100 $^\circ\text{C}$	
Lead Soldering Temperature [4mm (.157") From Body]	260 $^\circ\text{C}$ for 5 Seconds	

### Electrical and optical characteristics ( $T_a = 25^\circ\text{C}$ )

Parameter	Symbol	Min.	Typ.	Max.	Unit	Test Condition
Luminous Intensity	$I_v$	-	180	-	mcd	$I_F = 20\text{mA}$
Viewing Angle	$2\theta_{1/2}$	90	100	110	Deg	$I_F = 20\text{mA}$
Peak Emission Wavelength	$\lambda_p$	-	630	-	nm	$I_F = 20\text{mA}$
Dominate Wavelength	$\lambda_d$	-	625	-	nm	$I_F = 20\text{mA}$
Spectral Line Half-Width	$\Delta\lambda$	10	15	20	nm	$I_F = 20\text{mA}$
Forward Voltage	$V_F$	1.7	1.9	2.5	V	$I_F = 20\text{mA}$
Reverse Current	$I_R$			10	$\mu\text{A}$	$V_R = 5\text{V}$

## Typical Electrical Characteristics Curves (25 °c Ambient Temperature Unless Otherwise Noted)

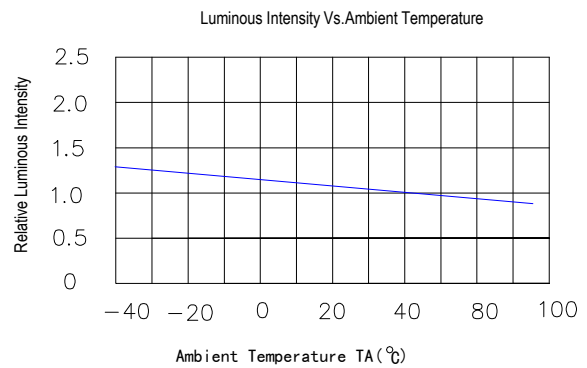
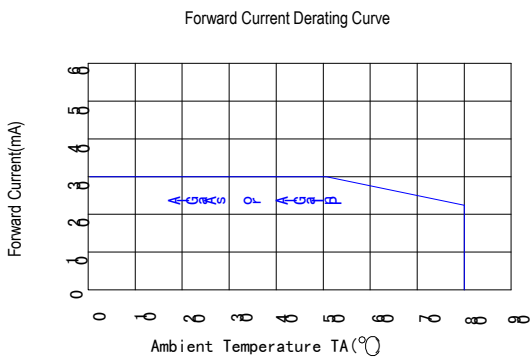
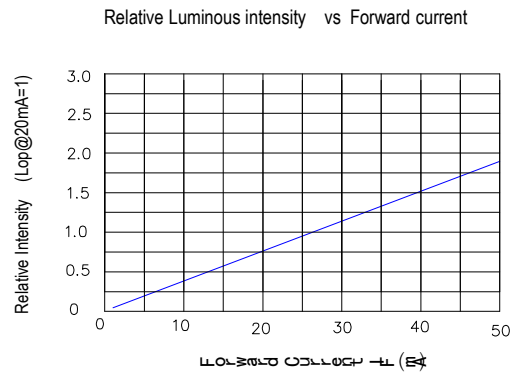
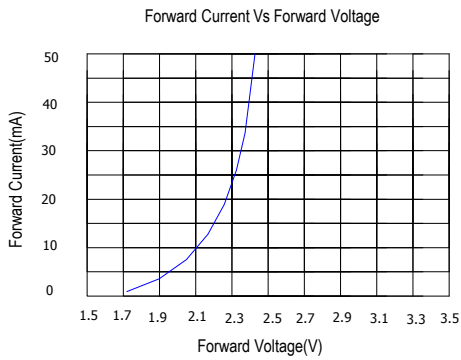
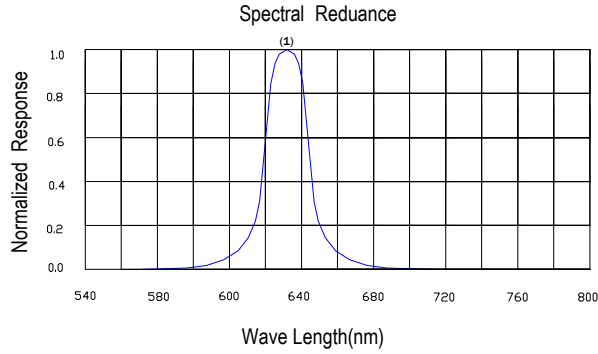

## LAMP PACKING.

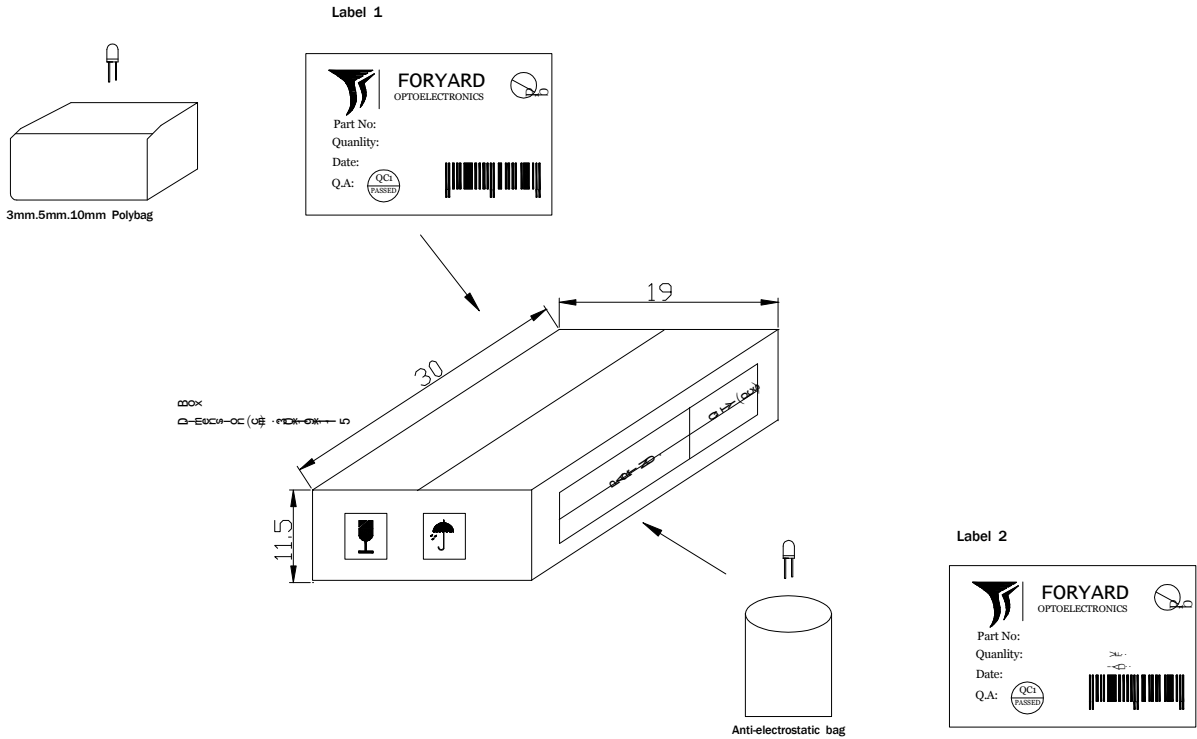

DEVICE	QTY/polybag(pcs)	Polybag/box A	Fig
5mm(T-1 3/4)	1000	8 bags	Label 1
3mm(T-1 )	1000	10 bags	Label 1
10mm(T-1)	250	8 bags	Label 1
Blue/Green/White	500pcs	8 bags	Label 2

**CARTON**  
Dimension(cm):39\*32\*38

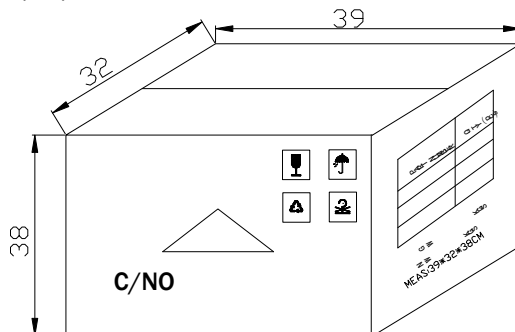

6 Boxes/Carton  
5mm:48,000pcs  
3mm:60,000pcs  
10mm:12,000pcs  
Blue/Pure Green/bluish Green  
/White:24,000pcs