

## FYLF- 1130UY1C

### Features:

- High intensity
- General purpose leads
- RoHs complant.

### Descriptions:

- Dice material: AlGaInP
- Emitting Color: Super bright yellow
- Lens Type: Water clear

### Radiation pattern.

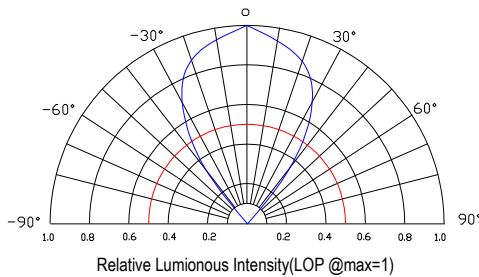

### Package configuration

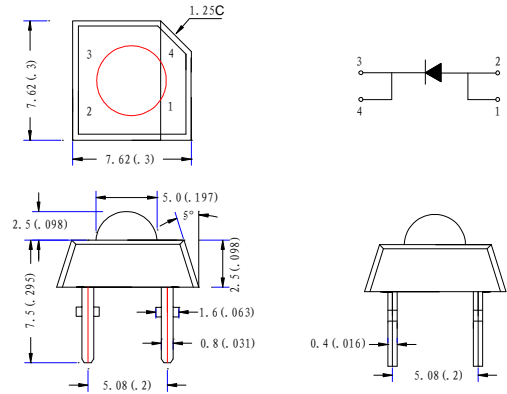

- ◆ All dimensions are millimeters (inches)
- ◆ Tolerance is  $\pm 0.25\text{mm}(0.010")$  unless otherwise noted.

### Absolute maximum ratings(Ta=25 °c)

Parameter	MAX.	Unit
Power Dissipation	50	mW
Peak Forward Current (1/10 Duty Cycle, 0.1ms Pulse Width)	100	mA
Continuous Forward Current	20	mA
Derating Linear From 50°C	0.4	mA/°C
Reverse Voltage	5	V
Operating Temperature Range	-30°C to +80°C	
Storage Temperature Range	-40°C to +100°C	
Lead Soldering Temperature[4mm(.157") From Body]	260°C for 5 Seconds	

### Electrical and optical characteristics(Ta=25 °c)

Parameter	Symbol	Min.	Typ.	Max.	Unit	Test Condition
Luminous Intensity	$I_v$	-	1100	-	mcd	$I_F=20\text{mA}$
Viewing Angle	$2\theta_{1/2}$	65	75	85	Deg	
Peak Emission	$\lambda_p$	583	588	593	nm	
Dominant Wavelength	$\lambda_d$	585	590	595	nm	
Spectral Line Half-Width	$\Delta\lambda$	10	15	20	nm	
Forward Voltage	$V_F$	1.8	2.0	2.3	V	$V_R=5V$
Reverse Current	$I_R$			50	$\mu\text{A}$	

## Typical Electrical Characteristics Curves (25 °c Ambient Temperature Unless Otherwise Noted)

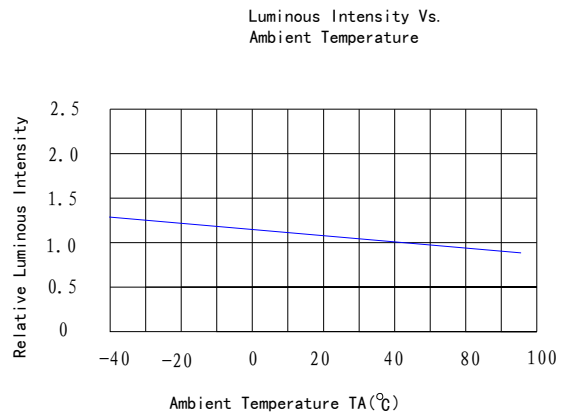
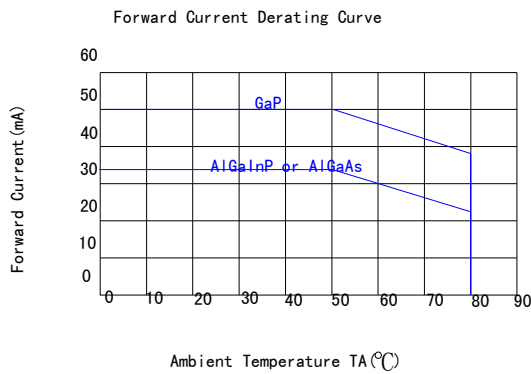
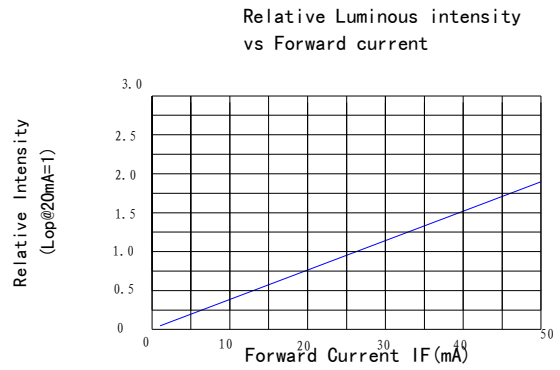
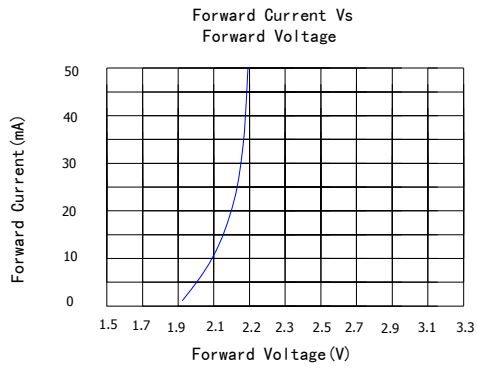
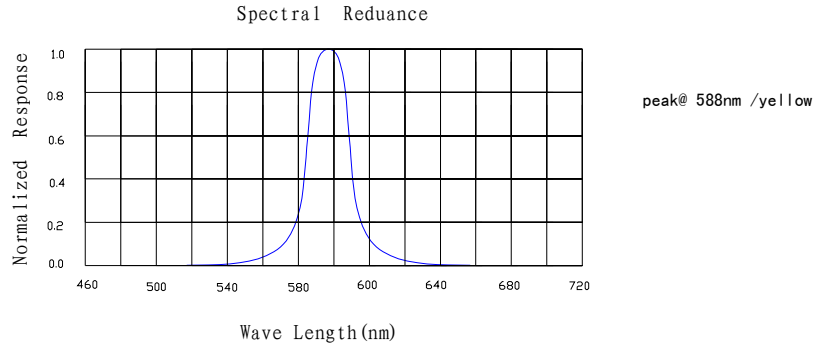

## Flux LEDs PACKING.

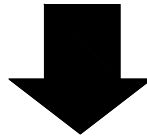
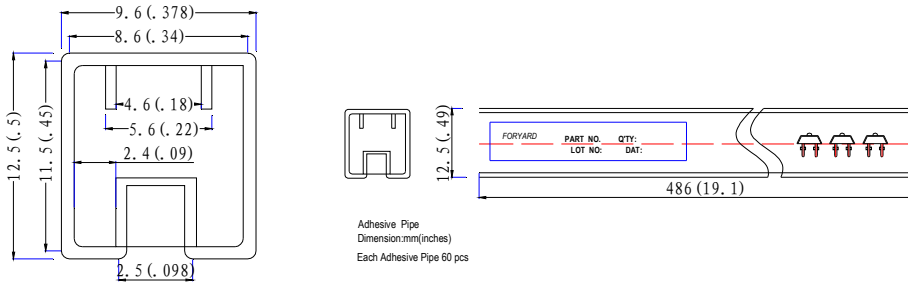

Box  
Dimension (cm) : 53\*15\*16.5

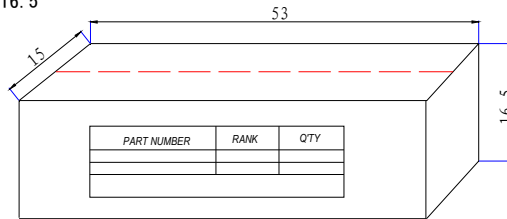

Each box/carotn 10,000pcs

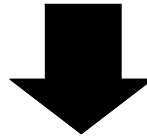

**CARTON**  
Dimension(cm):56\*32\*34.4

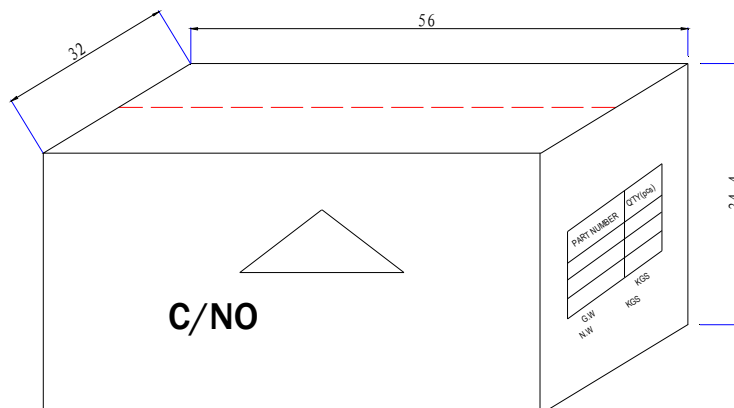

**4 Boxes/Carton**  
**Totail :40,000pcs**