

## FYLS - 3528URC

### Features:

- Suitable for all SMT assembly and solder process.
- Available on tape and Reel
- Package : 2000pcs/ Reel

### Description.

- The Red source color devices are made with Gallium Arsenide Phosphide on Gallium Phosphide Red Light Emitting Diode.
- It is recommended to use a wrist band or anti-electrostatic glove when handling the LEDs.
- All devices equipment and machinery must be electrically grounded.

### Package Dimensions

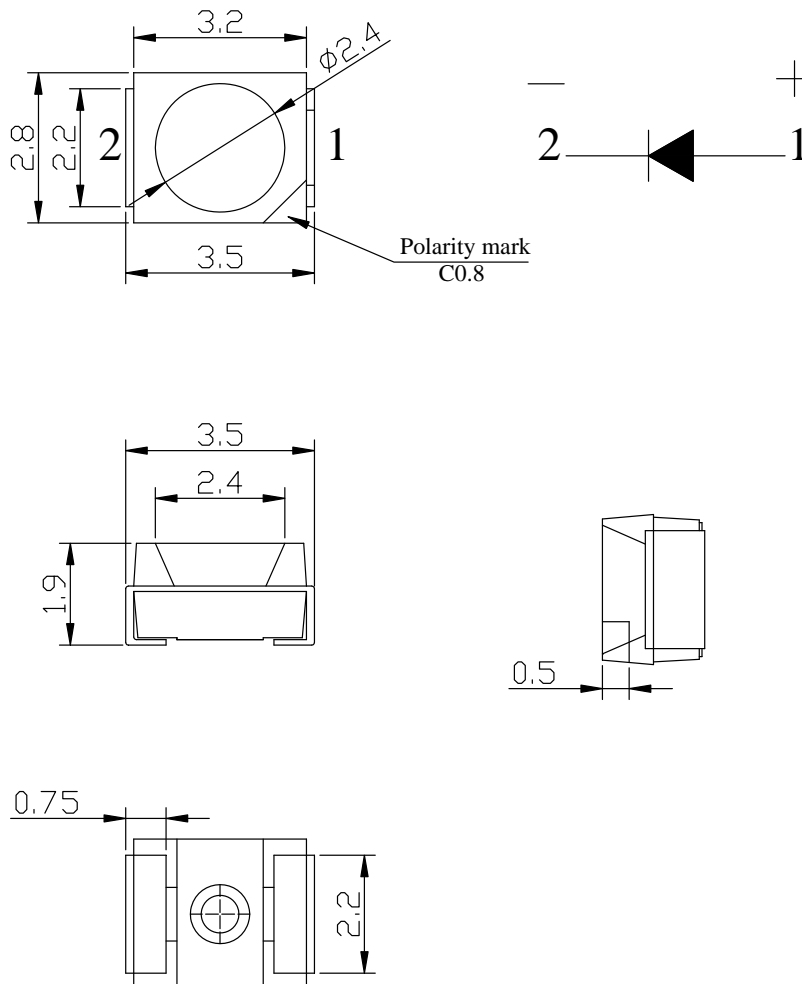

### Notes:

1. All dimension units are millimeters (Inches)
2. All dimension tolerance  $\pm 0.2\text{mm}$  unless otherwise noted.
3. An epoxy meniscus may extend about 1.5mm down the leads.

## Selection Guide

Part No.	Dice	lens type	IV(mcd)@20mA		Viewing Angle
			Min	Typ	2θ <sub>1/2</sub>
FYLS-3528URC	Red(AIGaInP)	Water clear	—	600	120

## Electrical/Optical Characteristics at Ta=25 °c

Symbol	Parameter	Device	min.	typ.	units	test conditions
λd	Dominate wavelength	Red	620	625	nm	IF=20mA
VF	Forward Voltage	Red	1.7	2.0	V	IF=20mA
IR	Reverse Current	Red		5	μA	VR=5V

## Absolute Maximum Ratings At= 25 °c

Parameter	White	Units
Power dissipation	75	mW
DC Forward Current	20	mA
Peak Forward Current(1)	185	mA
Reverse Voltage	5	V
Operating/storage Temperature	-40°C to +85°C	

### Note:

1. 1/10 Duty Cycle, 0.1ms Pulse Width.



# SMD

## Typical Electrical/Optical Characteristics Curves(Ta=25°C Unless Otherwise Noted)

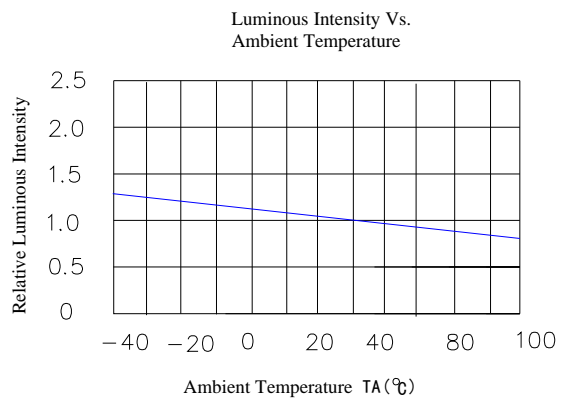
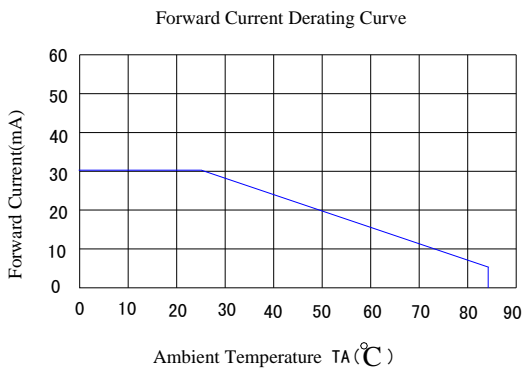
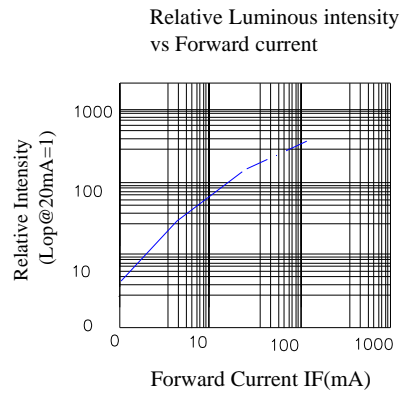
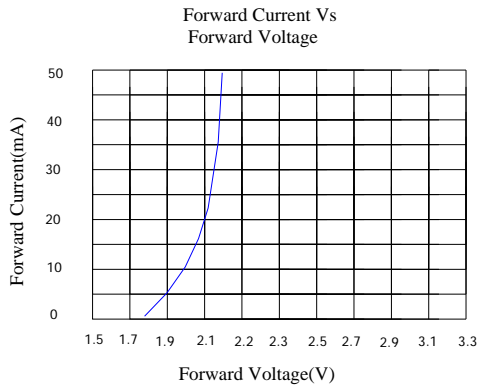
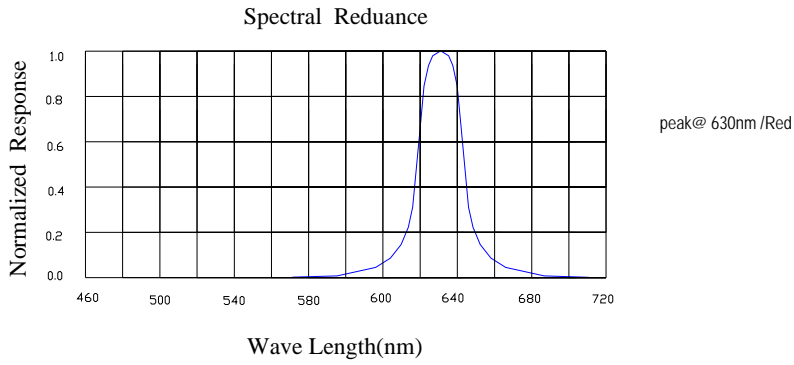

# SMD

## Precautions for use:

1. Suggest the LEDs should be kept between 5°C and 30°C and 60%RH or less before opening the package, The max. storage period before opening the package is 1 year.
2. After opening the package, the LEDs should be kept at 30°C/35%RH or less, and it should be used within 1 hours. In the event of incomplete usage, it is advised that user preheat the remaining devices at 60±5°C for 12 hours prior to use.
3. The temperature of manual of soldering not more then 300°C within 2 sec. The temperature of Reflow soldering not more then 260°C within 2 sec, should not be done more than twice. When soldering, don't tress on LEDs during heating. After soldering, don't warp the circuit board.
4. Repair should not be done after the LEDs have been soldered. When repair is unavoidable, Double-head soldering iron should be used. It should be confirmed beforehand whether the characteristics of the LEDs will be damaged by repair or not.

- (1) Reflow soldering  
Temperature profile

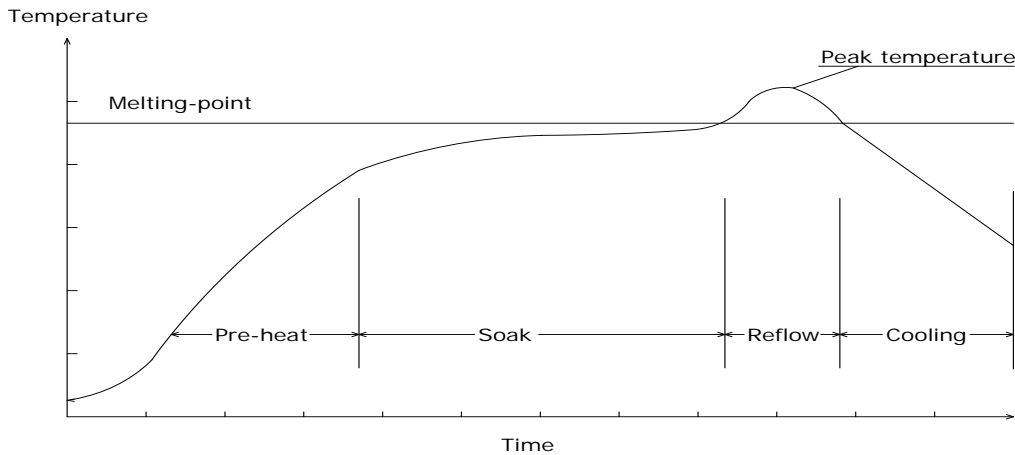

Solder=Sn63-Pb37	Solder= Pb-Free
Average ramp-up rate: 4°C/sec.max	Average ramp-up rate: 4°C/sec.max
Peak preheat temperature: 100-150°C	Peak preheat temperature: 100-150°C
preheat time: 100seconds.max	preheat time: 100seconds.max
ramp-down rate: 6°C/sec.max	ramp-down rate: 6°C/sec.max
Peak temperature: 230°C	Peak temperature: 250°C
Time within 5°C of actual peak temperature=10 sec. max	Time within 5°C of actual peak temperature=10 sec. max
Duration above 183°C is 80 sec. max	Duration above 217°C is 80 sec. max



## ◆ Packing and Shipping Spec.

