

PartNO.: FYS-3611AX/BX-XX

DESCRIPTION

- 9.1mm (0.36") Single digit numeric display series.
- Standard brightness.
- Low current operation.
- Excellent character appearance.
- Easy mounting on P.C.boards or sockets

Package Dimensions & Internal Circuit Diagram

FYS-3611 Series

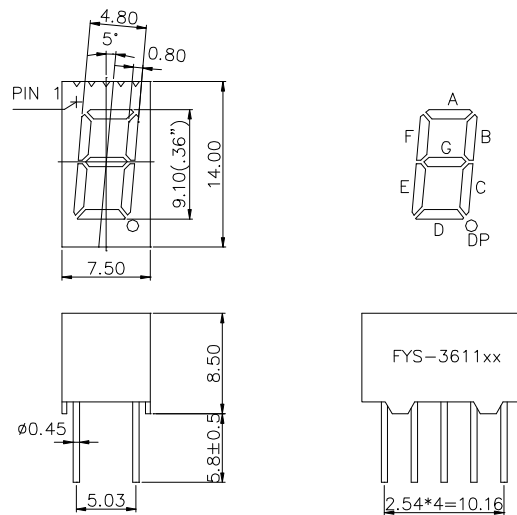

FYS-3611Ax

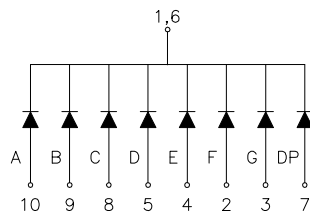

FYS-3611Bx

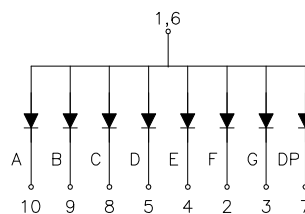

Notes:

- All dimensions are in millimeters (inches)
- Tolerance is $\pm 0.25(0.01)$ unless otherwise noted.
- Specifications are subject to change without notice.

PartNO.: FYS-3611AX/BX-XX

: Absolute maximum ratings (Ta=25°C)

| Parameter | Symbol | Test Condition | Value | | Unit |
|-----------------------|--------|---------------------|-------|-------|------|
| | | | Min | Max | |
| Reverse Voltage | VR | IR=30μA | 5 | ----- | V |
| Forward Current | IF | ----- | ----- | 30 | mA |
| Power Dissipation | Pd | ----- | ----- | 100 | mW |
| Pulse Current | Ipeak | Duty=0.1mS, 1KHz | ----- | 150 | mA |
| Operating Temperature | Topr | ----- | -40 | +85 | ° C |
| Storage Temperature | Tstr | ----- | -40 | +85 | ° C |

• -XX: Surface / Lens color:

| Number | 0 | 1 | 2 | 3 | 4 | 5 |
|-------------------|-------------|----------------|--------------|----------------|-----------------|---|
| Ref Surface Color | White | Black | Gray | Red | Green | |
| Epoxy Color | Water clear | White diffused | Red Diffused | Green Diffused | Yellow Diffused | |

PartNO.: FYS-3611AX/BX-XX

■ **Description:**

• Color Code & Chip characteristics: **(Test Condition: IF=20mA)**

| Emitting Color | | Dice Material | Peak Wave Length(λ_P) | Spectral Line halfwidth($\Delta\lambda_{1/2}$) | Forward Voltage(VF) Unit:V | | Luminous Intensity (Iv) Unit:mcd |
|---|------------------|---------------|---------------------------------|--|-------------------------------|------|-------------------------------------|
| | | | | | Typ | Max | |
| H | Red | GaP | 700nm | 90nm | 2.20 | 2.50 | 5.0 |
| S, SR | Hi Red | AlGaAs,SH | 660nm | 20nm | 1.80 | 2.20 | 15-20 |
| D | Super Red | AlGaAs,DH | 660nm | 20nm | 1.80 | 2.20 | 20-30 |
| LR | Ultra Red | AlGaAs,DDH | 660nm | 20nm | 1.90 | 2.40 | 26-38 |
| HR | HE Red | GaAsP | 640nm | 45nm | 1.90 | 2.40 | 50-80 |
| E | Orange | GaAsP | 630nm | 35nm | 2.10 | 2.50 | 10-20 |
| A | Amber | GaAsP | 610nm | 35nm | 2.10 | 2.50 | 15-20 |
| Y | Yellow | GaAsP | 590nm | 35nm | 2.10 | 2.50 | 15-20 |
| G | Green | GaP | 570nm | 30nm | 2.20 | 2.50 | 14-18 |
| Ultra brightness | | | | | | | |
| UH R | Ultra Hi Red | AlGaInP | 645nm | 20nm | 2.10 | 2.50 | 80-150 |
| UE | Ultra Orange | AlGaInP | 630nm | 20nm | 2.10 | 2.50 | 180-210 |
| UA | Ultra Amber | AlGaInP | 610nm | 20nm | 2.10 | 2.50 | 90-120 |
| UY | Ultra Yellow | AlGaInP | 590nm | 20nm | 2.10 | 2.50 | 150-200 |
| UG | Ultra Green | AlGaInP | 570nm | 30nm | 2.20 | 2.50 | 60-100 |
| PG | Ultra Pure Green | InGaN | 520nm | 36nm | 2.80 | 3.80 | 260-310 |
| BG | Ultra Blue Green | InGaN | 505nm | 36nm | 2.80 | 3.80 | 260-310 |
| B | Blue | InGaN | 430nm | 30nm | 2.80 | 3.80 | 10-20 |
| UB | Ultra Blue | InGaN | 470nm | 30nm | 2.80 | 3.80 | 80-90 |
| V | UV | InGaN | 405nm | | 2.80 | 3.80 | 5-8 |
| W | White | InGaN | X=0.29,y=0.30 | | 2.80 | 3.80 | 180-200 |
| U W | Ultra White | InGaN | X=0.29,y=0.30 | | 2.80 | 3.80 | 180-200 |
| Segment-to-Segment Luminous Intensity ratio(Iv-M) | | | | | 1.5:1 | | |

PartNO.: FYS-3611AX/BX-XX

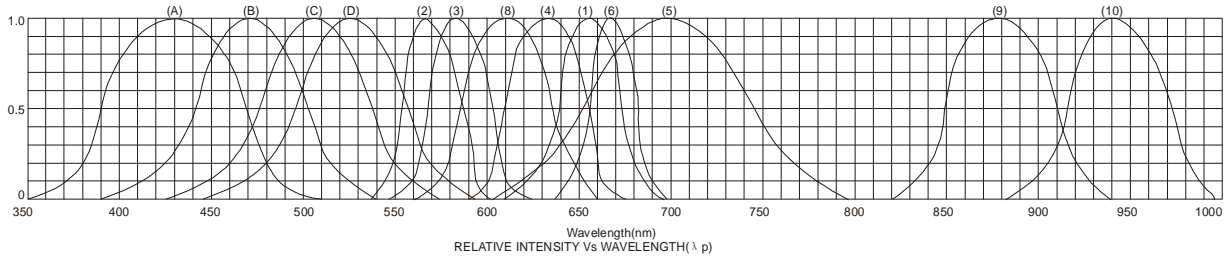

- | | |
|---|--------------------------------------|
| (1) - GaAsP/GaAs 655nm/Red | (9) - GaAlAs 880nm |
| (2) - GaP 570nm/Yellow Green | (10) - GaAs/GaAs & GaAlAs/GaAs 940nm |
| (3) - GaAsP/GaP 585nm/Yellow | (A) - GaN/SiC 430nm/Blue |
| (4) - GaAsP/GaP 635nm/Orange & Hi-Eff Red | (B) - InGaN/SiC 470nm/Blue |
| (5) - GaP 700nm/Bright Red | (C) - InGaN/SiC 505nm/Ultra Green |
| (6) - GaAlAs/GaAs 660nm/Super Red | (D) - InGaAl/SiC 525nm/Ultra Green |
| (8) - GaAsP/GaP 610nm/Super Red | |

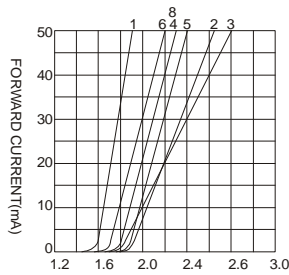

FORWARD VOLTAGE (Vf)
FORWARD CURRENT VS.
FORWARD VOLTAGE

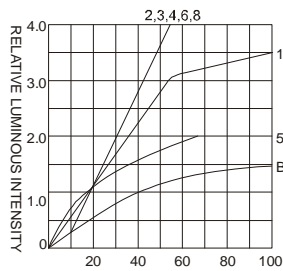

FORWARD CURRENT (mA)
RELATIVE LUMINOUS
INTENSITY VS. FORWARD
CURRENT

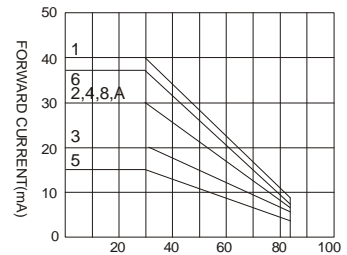

AMBIENT TEMPERATURE Ta(°C)
FORWARD CURRENT VS. AMBIENT
TEMPERATURE

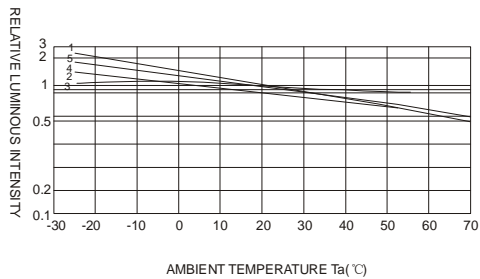

AMBIENT TEMPERATURE Ta(°C)

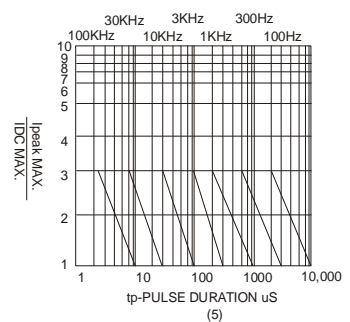
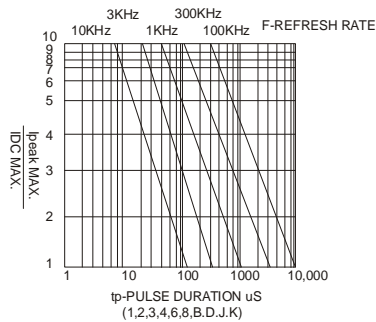

NOTE: 25°C free air temperature unless otherwise specified

