

# Переключатели мгновенного действия

## Features

- High precision basic switch in a variety of styles
- Wide margins of operating conditions increase the operating speed range
- Available in general purpose



## Specifications

Item	Standard
Rating	20(4)A 250VAC (EN 61058-1) 15A 125VAC or 250VAC (UL 1054) 1/2A 125VDC 1/4A 250VDC 1/8HP 125VAC 1/4HP 250VAC
Contact Resistance	15mΩ max. (initial)
Insulation Resistance	100MΩ min.( at 500V DC)
Dielectric Strength	Between terminals of same polarity AC 1000V (50/60Hz for 1minute)
Electrically Life	100,000 operations min.
Mechanically Life	1,000,000 operations min.

## Product Selection

Z15G   
1

### 1.SOLDER ACTUATOR TYPES

- 1100:Pin plunger
- 1101:Hinge lever
- 1103:Short hinge roller lever
- 1105: Slim spring plunger
- 1106:Short spring plunger
- 1107:Panel mount plunger
- 1108:Panel mount roller plunger
- 1118:Panel mount cross roller plunger
- 1501:Hinge lever
- 1502:Short Hinge lever
- 1503:Hinge roller lever
- 1504:Short hinge roller lever
- 1544:Unidirectional short hinge roller lever

### 2.SCREW ACTUATOR TYPES

- 1300:Pin plunger
- 1301:Hinge lever
- 1303:Short hinge roller lever
- 1305: Slim spring plunger
- 1306:Short spring plunger
- 1307:Panel mount plunger
- 1308:Panel mount roller plunger
- 1318:Panel mount cross roller plunger
- 1701:Hinge lever
- 1702:Short Hinge lever
- 1703:Hinge roller lever
- 1704:Short hinge roller lever
- 1744:Unidirectional short hinge roller lever

## Terminals

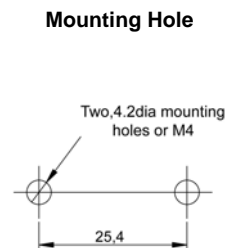
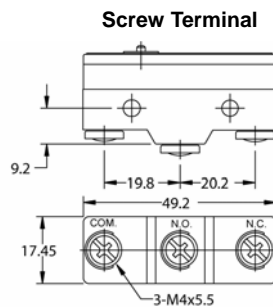
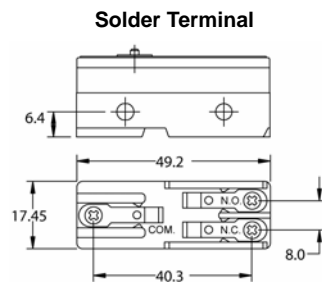

# Переклюатели мгновенного действия

## Operating Characteristics

Unit :mm

### Item NO.

### Dimensions

#### Z15G1300



Terminal	Item No.
Solder	Z15G1100
Screw	Z15G1300
OF	250—350g
RF min.	114g
PT max.	0.4 mm
OT min.	0.13 mm
MD max.	0.05 mm
OP	15.9±0.4 mm

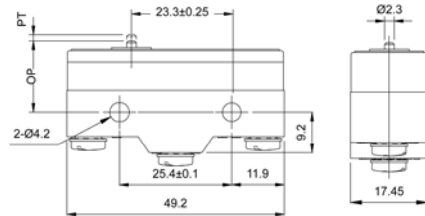

#### Z15G1301



Terminal	Item No.
Solder	Z15G1101
Screw	Z15G1301
OF max.	141g
RF min.	14g
PT max.	4 mm*
OT min.	1.6 mm
MD max.	1.3 mm
FP max.	20.6 mm
OP	17.4±0.8 mm

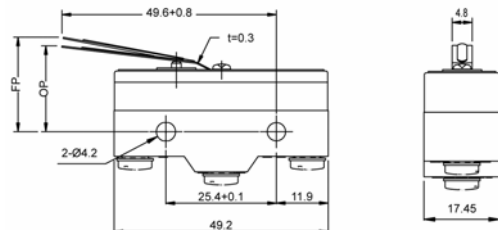

#### Z15G1303



Terminal	Item No.
Solder	Z15G1103
Screw	Z15G1303
OF max.	141g
RF min.	14g
PT max.	4 mm*
OT min.	1.6 mm
MD max.	1.3 mm
FP max.	31.8 mm
OP	28.6±0.8 mm

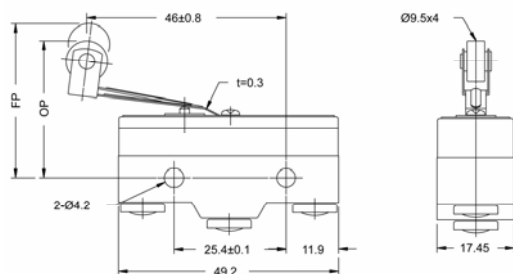

#### Z15G1305



Terminal	Item No.
Solder	Z15G1105
Screw	Z15G1305
OF	250—350g
RF min.	114g
PT max.	0.4 mm
OT min.	1.6 mm
MD max.	0.05 mm
OP	28.2±0.5 mm

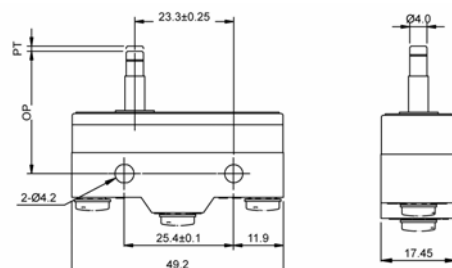

# Переключатели мгновенного действия

## Operating Characteristics

Unit :mm

Item NO.

Dimensions

### Z15G1306



Terminal	Item No.
Solder	Z15G1106
Screw	Z15G1306
OF	250—350g
RF min.	114g
PT max.	0.4mm
OT min.	1.6mm
MD max.	0.05mm
OP	21.5±0.5mm

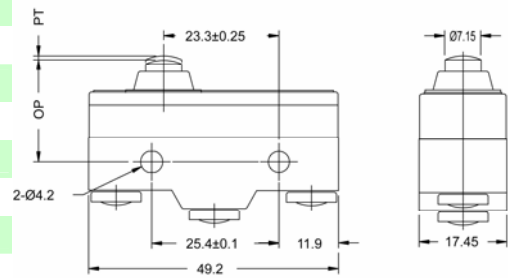

### Z15G1307



Terminal	Item No.
Solder	Z15G1107
Screw	Z15G1307
OF	250—350g
RF min.	114g
PT max.	0.4mm
OT min.	5.5mm
MD max.	0.05mm
OP	21.8±0.8mm

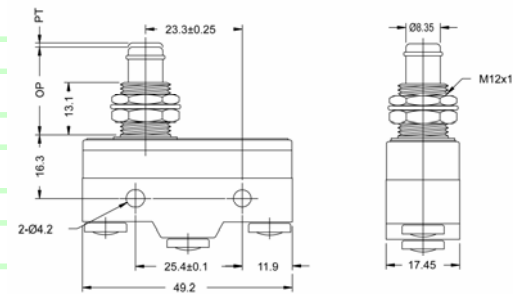

### Z15G1308



Terminal	Item No.
Solder	Z15G1108
Screw	Z15G1308
OF	250—350g
RF min.	114g
PT max.	0.4mm
OT min.	3.58mm
MD max.	0.05mm
OP	33.4±1mm

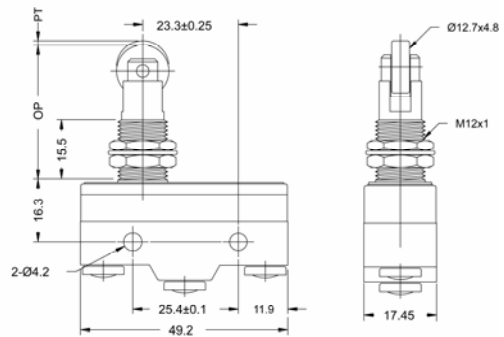

### Z15G1318



Terminal	Item No.
Solder	Z15G1118
Screw	Z15G1318
OF	250—350g
RF min.	114g
PT max.	0.4mm
OT min.	3.58mm
MD max.	0.05mm
OP	33.4±1mm

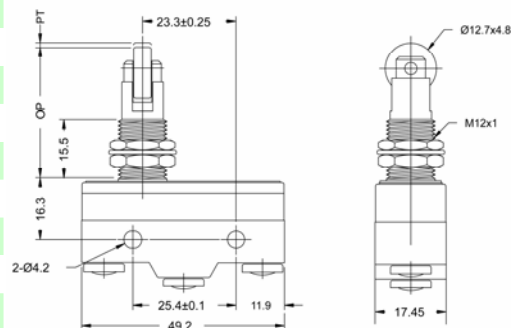

# Переключатели мгновенного действия

## Operating Characteristics

Unit :mm

Item NO.

Dimensions

### Z15G1701



Terminal	Item No.
Solder	Z15G1501
Screw	Z15G1701
OF max.	70g
RF min.	14g
PT max.	10mm*
OT min.	5.6mm
MD max.	1.27mm
FP max.	28.2mm
OP	19±0.8mm

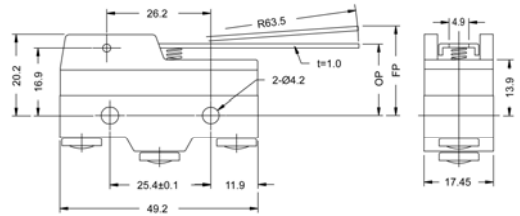

### Z15G1702



Terminal	Item No.
Solder	Z15G1502
Screw	Z15G1702
OF max.	90g
RF min.	18g
PT max.	8mm
OT min.	4.2mm
MD max.	1mm
FP max.	26.2mm
OP	19.8±0.8mm

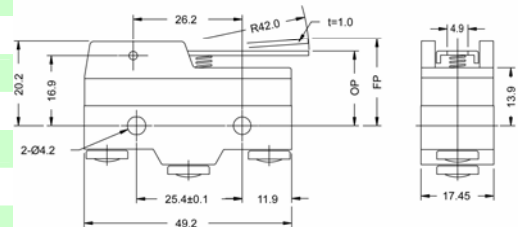

### Z15G1703



Terminal	Item No.
Solder	Z15G1503
Screw	Z15G1703
OF max.	100g
RF min.	22g
PT max.	7.1mm
OT min.	4mm
MD max.	1.02mm
FP max.	32.5mm
OP	30.2±0.4mm

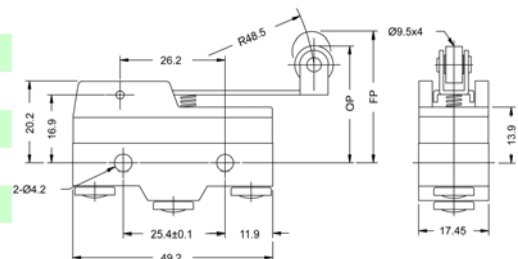

### Z15G1704



Terminal	Item No.
Solder	Z15G1504
Screw	Z15G1704
OF max.	160g
RF min.	42g
PT max.	2.7mm
OT min.	2.4mm
MD max.	0.5mm
FP max.	32.5mm
OP	30.2±0.4mm

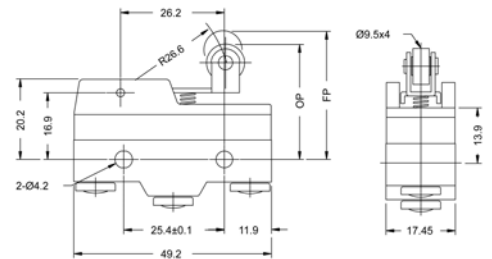

# Переключатели мгновенного действия

## Operating Characteristics

Unit :mm\_

Item NO.

Dimensions

### Z15G1744



Terminal	Item No.
Solder	Z15G1544
Screw	Z15G1744
OF max.	170g
RF min.	42g
PT max.	2.7mm*
OT min.	2.4mm
MD max.	0.51mm
FP max.	43.6mm
OP	41.3±0.8mm

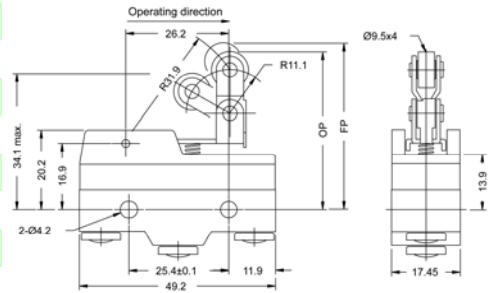

### ZP15G1306



Terminal	Item No.
Solder	ZP15G1106
Screw	ZP15G1306
OF max.	540g
RF min.	114g
PT max.	2.3mm
OT min.	1.6mm
MD max.	0.06mm
OP	28.2±0.5mm

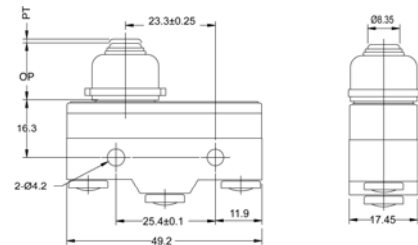

### TERMINAL ENCLOSURES AA8000

