

SPECIFICATION FOR APPROVAL

REF :

PAGE: 1

PROD. NAME	SMD BALUN TRANSFORMER	ABC'S DWG NO.	SC6036□□□□L□-□□□
		ABC'S ITEM NO.	

I . MECHANICAL DIMENSIONS :

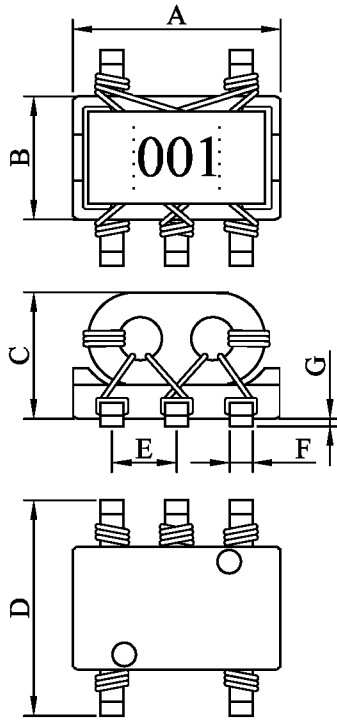

- A : 6.20±0.20 m/m
- B : 4.00±0.20 m/m
- C : 3.60 max. m/m
- D : 6.40±0.30 m/m
- E : 2.00 typ. m/m
- F : 0.60±0.05 m/m
- G : 0.20±0.10 m/m
- H : 0.30±0.10 m/m
- I : 0.70±0.05 m/m
- J : 0°~ 8° m/m

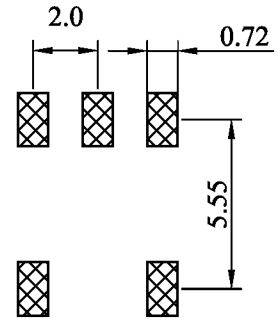
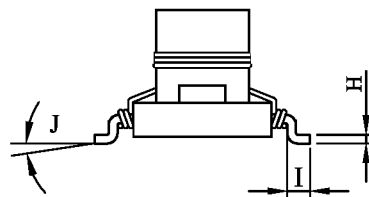

(PCB Pattern)

II . MATERIALS :

- a. Core : Ferrite RID core
- b. Base : Phenolic
- c. Wire : Enamelled copper wire (class F)
- d. Adhesive : Epoxy resin
- e. Terminal : Cu/Ni/Sn
- f. Remark : Products comply with RoHS' requirements

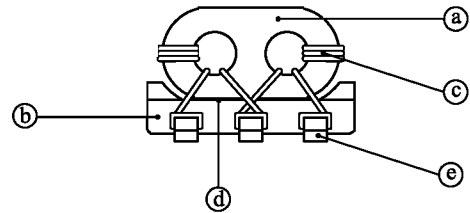

Peak Temp : 260°C max.
 Max time above 230°C : 50sec max.
 Max time above 200°C : 70sec max.

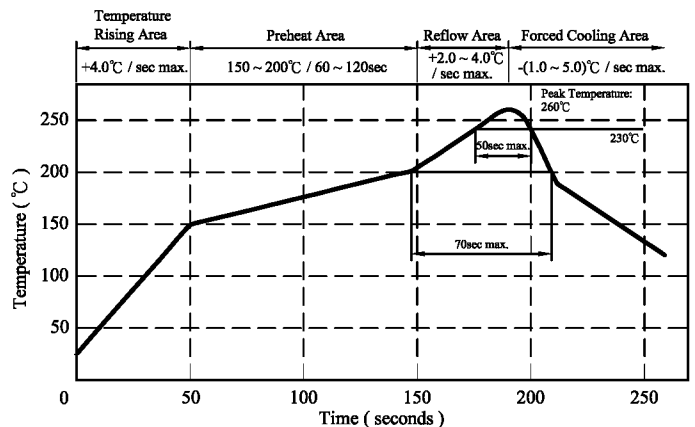

III . APPLICATIONS :

- a. Double balance mixers , Broad-Band Transformers , Impedance Transformers, ETC.

AR-001A

SPECIFICATION FOR APPROVAL

REF :

PAGE: 2

PROD. NAME	SMD BALUN TRANSFORMER	ABC'S DWG NO.	SC6036□□□□L□-□□□
		ABC'S ITEM NO.	

IV . ELECTRICAL CHARACTERISTICS :

DWG No.	Winding turns	Operating frequency range	Insertion loss	Pin connection fig.
SC60360001L□-□□□	2.0	30.0MHz- 850MHz	3.0dB max.	1
SC60360002L□-□□□	3.0	5.0MHz-1000MHz	3.0dB max.	1
SC60360003L□-□□□	4.0	9.0MHz-1700MHz	3.0dB max.	1
SC60360004L□-□□□	5.0	5.5MHz-1500MHz	3.0dB max.	1
SC60360005L□-□□□	1.0	20.0MHz- 400MHz	7.0dB max.	2
SC60360006L□-□□□	2.0	8.0MHz- 550MHz	3.0dB max.	2
SC60360007L□-□□□	3.0	3.5MHz-500MHz	3.0dB max.	2
SC60360008L□-□□□	4.0	2.0MHz-370MHz	3.0dB max.	2
SC60360009L□-□□□	1.0	100.0MHz- 500MHz	7.0dB max.	2
SC60360010L□-□□□	2.0	500.0MHz-850MHz	3.0dB max.	2
SC60360011L□-□□□	3.0	240.0MHz-500MHz	3.0dB max.	2
SC60360012L□-□□□	4.0	85.0MHz-380MHz	3.0dB max.	2
SC60360013L□-□□□	1.5	10.0MHz-2000MHz	3.0dB max.	3
SC60360014L□-□□□	2.5	6.0MHz-2000MHz	3.0dB max.	3
SC60360015L□-□□□	3.5	6.0MHz-1700MHz	3.0dB max.	3
SC60360016L□-□□□	4.5	5.0MHz-1400MHz	3.0dB max.	3
SC60360017L□-□□□	5.5	5.0MHz-1300MHz	3.0dB max.	3
SC60360018L□-□□□	1.5	160.0MHz-2200MHz	3.0dB max.	4
SC60360019L□-□□□	2.5	60.0MHz-1700MHz	3.0dB max.	4
SC60360020L□-□□□	3.5	30.0MHz-1400MHz	3.0dB max.	4

1). □ : Packaging information ... [A]: Bulk [B]: Taping Reel

V . SCHEMATIC DIAGRAM :

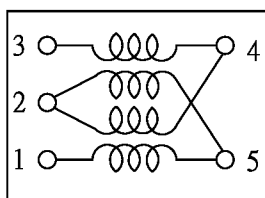

Double balanced
Fig.1

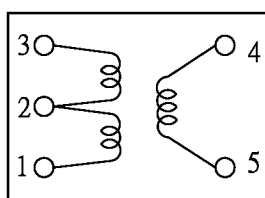

Transformer
Fig.2

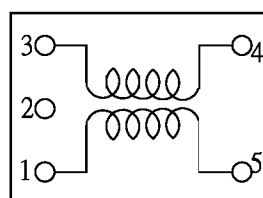

Transformer
Fig.3

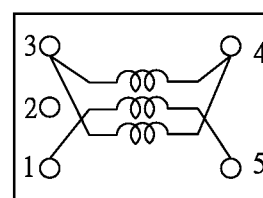

Transformer
Fig.4

AR-001A



千如電子集團
ABC ELECTRONICS GROUP.

SPECIFICATION FOR APPROVAL

REF :

PAGE: 3

PROD. NAME	SMD BALUN TRANSFORMER	ABC'S DWG NO.	SC6036□□□□L□-□□□
		ABC'S ITEM NO.	

VI . PACKAGING INFORMATION :

(1) Configuration

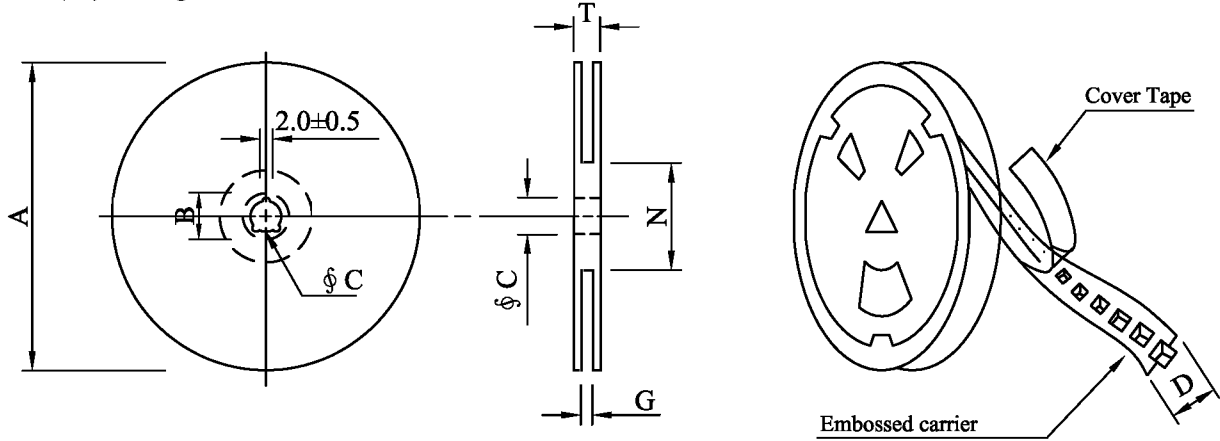

※Carrier tape width : D

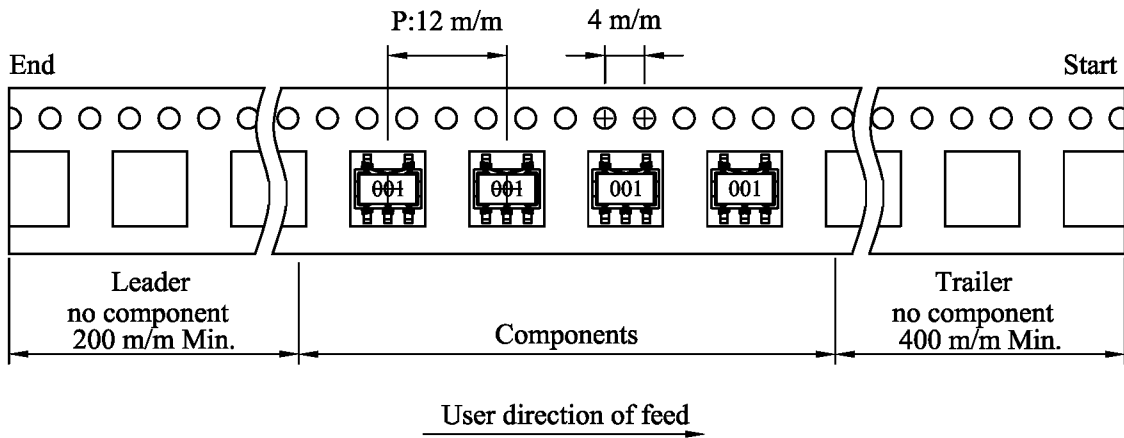

(2) Dimensions

Unit:m/m

Style	A	B	C	D	G	N	T
13 - 16	330	21±0.8	13±0.5	16	18 ⁺⁰	50 ⁻⁰	22.4

(3) Q'TY & G.W. Per package

Series	Inner : Reel			Outer : Carton		
	Q'TY (pcs)	G.W. (gw)	Style	Q'TY (pcs)	G.W. (Kg)	Size (cm)
SC6036	1,200	384	13 - 16	7,200	3.2	40 x 40 x 24

AR-001A

SPECIFICATION FOR APPROVAL

REF :

PAGE: 4

PROD. NAME	SMD BALUN TRANSFORMER	ABC'S DWG NO.	SC6036□□□□L□-□□□
		ABC'S ITEM NO.	

VII . DWGING NUMBER EXPRESSION :

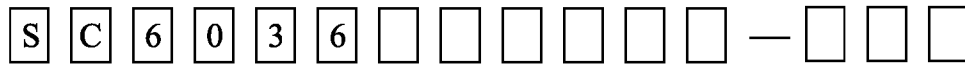

- Reference code
- Appendix code 2 : Package
- Appendix code 1 : Classification
- Sequency No.
- Dimension code
- Type code

Appendix code 1 : Product Classification

- L : Lead Free Standard products comply with RoHS' requirements
- 1 ~ 9 : Lead Free Special products comply with RoHS' requirements

Appendix code 2 : Package Information

Code	Inner package	Inner package Q'TY	Remark
A	T.B.D.	T.B.D.	
B	T / R (Reel package)	1200 pcs	

SPECIFICATION FOR APPROVAL

REF :

PAGE: 5

PROD. NAME	SMD BALUN TRANSFORMER	ABC'S DWG NO.	SC6036□□□□L□-□□□
		ABC'S ITEM NO.	

VIII . UL CARD :

OBMW2 September 8, 2000

Magnet Wire-Component

JUNG SHING WIRE CO LTD E174837

231 CHUNG CHENG RD, SEC 3 JEN-TEH HSIANG, TAINAN

HSIEN TAIWAN

Mtl Dsg	Mark Dsg	BC	Coat Typ	OC	ANSI Type	Temp Class
AIW	---	Polyamideimide	---	---	MW81-C	220
CFUEWB	---	Polyurethane	---	---	MW75C	130
EIAIW	---	Polyesterimide	Polyamideimide	---	MW35C	200
EILOCKY	---	Polyesterimide	Polyamide	---	---	180
EILOCKW	---	Polyesterimide	Modified Epoxy	---	---	200
EIW	---	Polyesterimide	---	---	---	220
EIW-2	---	Polyesterimide	---	---	MW74-C	200
FL.EILOCKY	---	Modified Polyester	Polyamide	---	---	155
LSFFW	---	Polyurethane	---	---	MW79-C	155
LSUEW	---	Polyurethane	---	---	---	130
PEW	---	Polyester	---	---	---	155
PEY	---	Polyester	Nylon	---	MW24-C	155
SF.FLW	---	Modified Polyester	---	---	MW26C	155
SF.EIW	---	Polyesterimide	---	---	MW77C	180
SF.BY@	---	Modified Polyester	Nylon	---	MW27-C	155
SF.FLY@	---	Modified Polyester	Nylon	---	MW27-C	155
SF.BLOCKBS	---	Modified Polyester	Modified Polyamide	---	---	155
SF.EILOCKY#	---	Polyesterimide	Polyamide	---	---	180
SF.EILOCKBS	---	Polyesterimide	Modified Polyamide	---	---	180
SF.BW@	---	Modified Polyester	---	---	MW26C	155
SFFW	---	Polyurethane	---	---	MW79	155

287806002 Page 1 of 2

A not-for-profit organization
dedicated to public safety and
committed to quality service

Mtl Dsg	Mark Dsg	BC	Coat Typ	OC	ANSI Type	Temp Class
SFFY	---	Polyurethane	Polyamide	---	MW80C	155
UEW-1	---	Polyurethane	---	---	MW2-C	105
UEW-2	---	Polyurethane	---	---	---	130
UEW-4	---	Polyurethane	---	---	MW75C	130
UEY	---	Polyurethane	Nylon	---	MW28-C	130
UEY-2	---	Polyurethane	Polyamide	---	MW28-C	130

@-May be suffixed by LZ; # - May be suffixed by LZ, EL or LZL.
LZ - Signifies magnet wires twisted together; EL - signifies base coated magnet wire laid parallel with top coat applied overall; LZL - signifies base coated magnet wire twisted together and covered with top coat overall.

Marking: Company name or trademarks **JSW** or 榮星電線 , material designation or marked designation on packaed or reel, and Recognized Component Mark.

See General Information Preceding These Recognitions
For use only in equipment where the acceptability of the combination is determined by Underwriters Laboratories Inc.

287806002 Page 2 of 2

OBMW2/E174837
September 8, 2000

SPECIFICATION FOR APPROVAL

REF :

PAGE: 6

PROD. NAME	SMD BALUN TRANSFORMER	ABC'S DWG NO.	SC6036□□□□L□-□□□
		ABC'S ITEM NO.	

		SUMITOMO CHEMICAL CO LTD						E54705 (M)				
		5-33 KITAHAMA 4-CHOME CHUO-KO, OSAKA JAPAN										
Mtl Dsg	Col	Min Thk mm	UL94 Flame Class	Elec	RTI		H W I	H A I	H V R	D 4 5	C T I	
					Mech with Imp	w/o Imp						
Liquid crystal polyester (LCP), designated "EKONOL" or "SUMIKASUPER", furnished in the form of pellets, (Contd)												
E4008 , E400X	NC , BK	0.30	94V-0	130	130	130	—	—	—	—	—	
		0.75	94V-0	130	130	130	3	4	—	—	—	
		1.5	94V-0	130	130	130	2	4	—	—	—	
		3.0	94V-0	130	130	130	1	4	0	5	4	
E4008	NC , WT , BK	0.30	94V-0	130	130	130	—	—	—	—	—	
		0.75	94V-0	220	180	220	3	4	—	—	—	
		1.5	94V-0	220	200	240	2	4	—	—	—	
		3.0	94V-0	220	200	240	1	4	0	5	4	
E4010	NC , BK	0.30	94V-0	130	130	130	—	—	—	—	—	
		0.75	94V-0	220	180	220	3	4	—	—	—	
		1.5	94V-0	220	200	240	2	4	—	—	—	
		3.0	94V-0	220	200	240	1	4	0	5	4	
E400(Y)L , E4008L	NC , BK	0.30	94V-0	130	130	130	—	—	—	—	—	
		0.75	94V-0	130	130	130	3	4	—	—	—	
		1.5	94V-0	130	130	130	2	4	—	—	—	
		3.0	94V-0	130	130	130	1	4	0	5	4	
E4810	NC , BK	0.30	94V-0	130	130	130	—	—	—	—	—	
		0.75	94V-0	130	130	130	0	4	—	—	—	
		1.5	94V-0	130	130	130	0	4	—	—	—	
		3.0	94V-0	130	130	130	1	4	0	5	4	

(X) Denotes any number 1 thru 9.
(Y) Denotes any number 1 thru 7.

SPECIFICATION FOR APPROVAL

REF :

PAGE: 7

PROD. NAME	SMD BALUN TRANSFORMER	ABC'S DWG NO.	SC6036□□□□L□-□□□
		ABC'S ITEM NO.	

IX . INSERTION LOSS TEST CURVE :

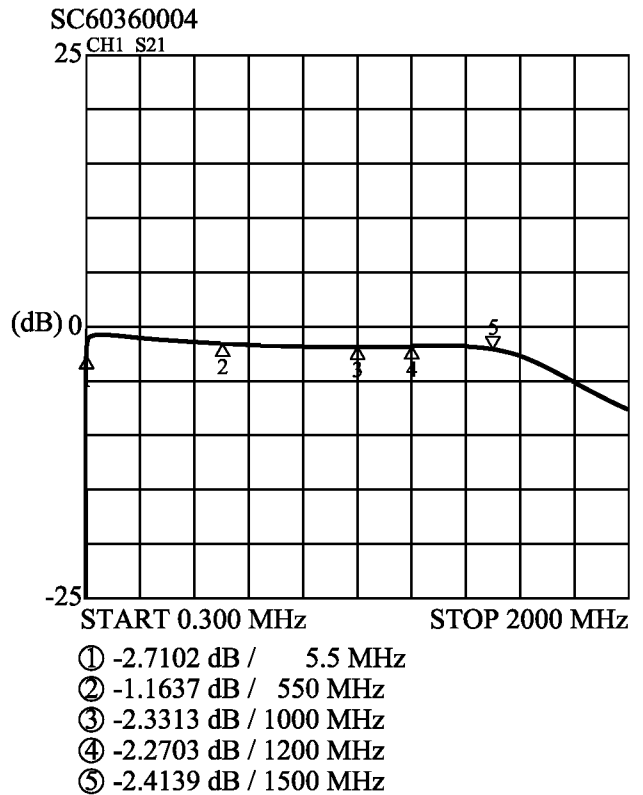
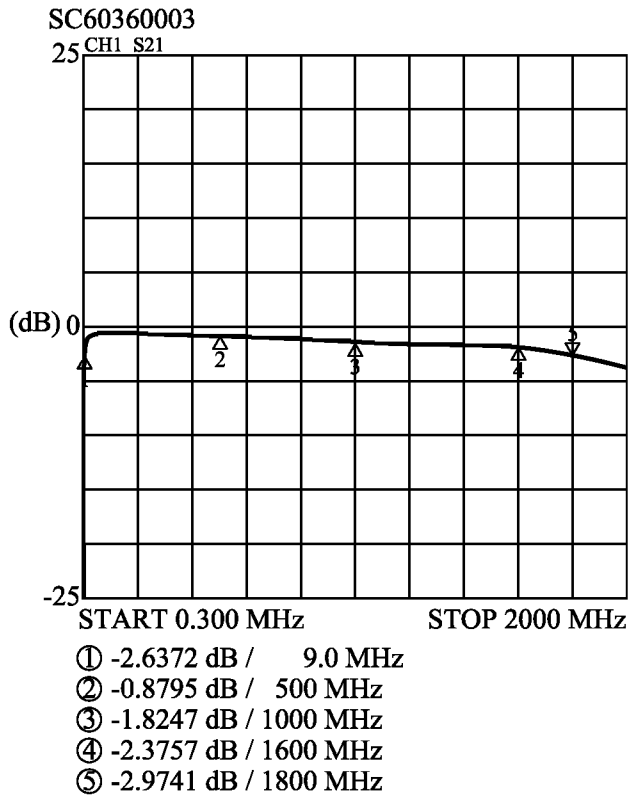
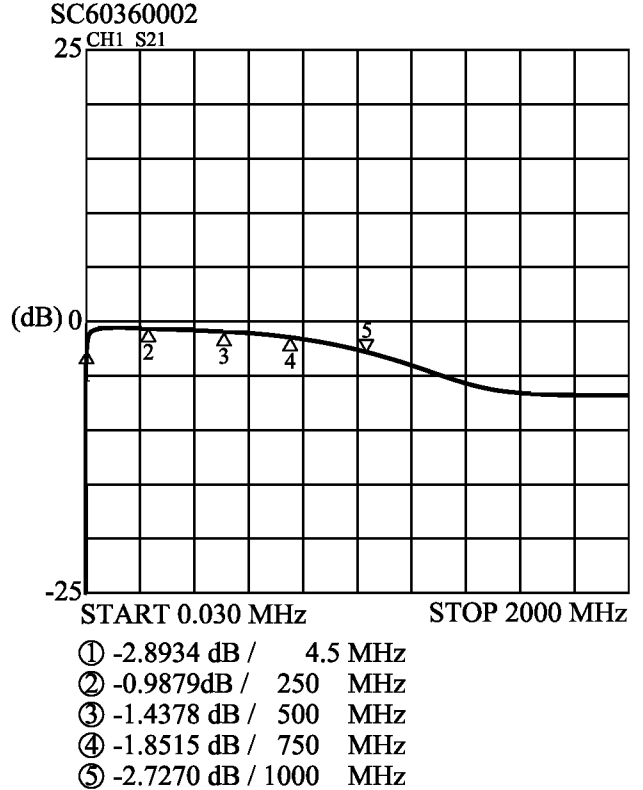
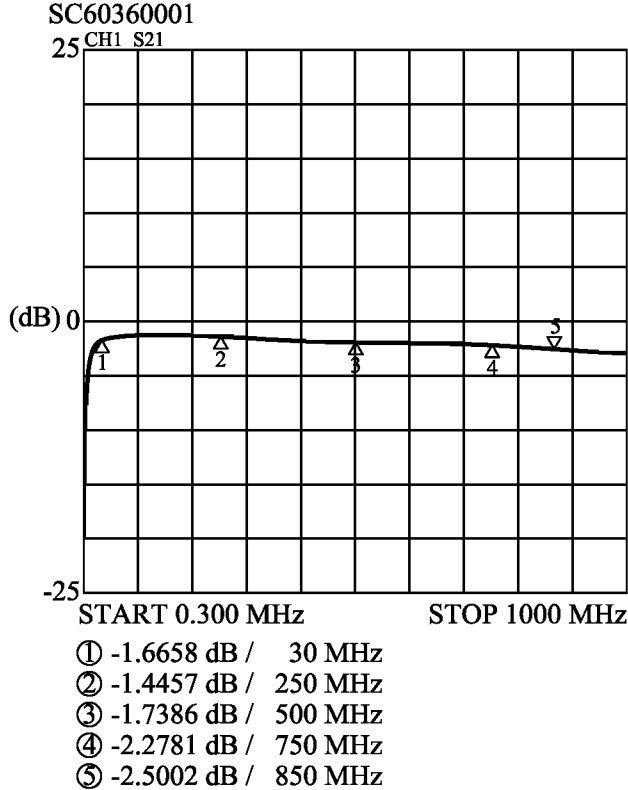

AR-001A

SPECIFICATION FOR APPROVAL

REF :

PAGE: 8

PROD. NAME	SMD BALUN TRANSFORMER	ABC'S DWG NO.	SC6036□□□□Lo-□□□
		ABC'S ITEM NO.	

SC60360005

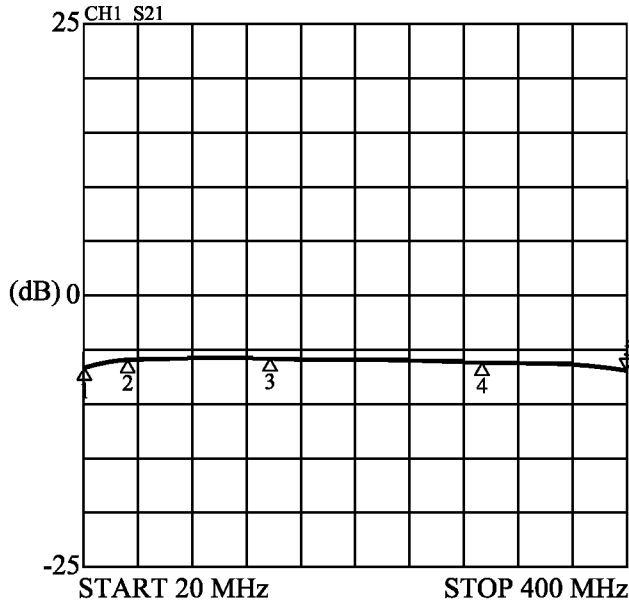

- ① -6.7986 dB / 20 MHz
- ② -5.8059 dB / 50 MHz
- ③ -5.5581 dB / 150 MHz
- ④ -6.2174 dB / 300 MHz
- ⑤ -6.8746 dB / 400 MHz

SC60360006

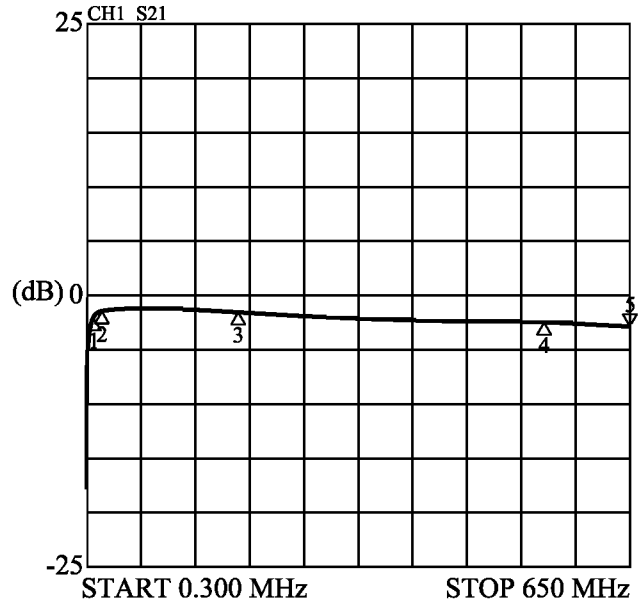

- ① -2.9701 dB / 5.5 MHz
- ② -2.5171 dB / 10 MHz
- ③ -2.3691 dB / 300 MHz
- ④ -2.8968 dB / 550 MHz
- ⑤ -3.0185 dB / 650 MHz

SC60360007

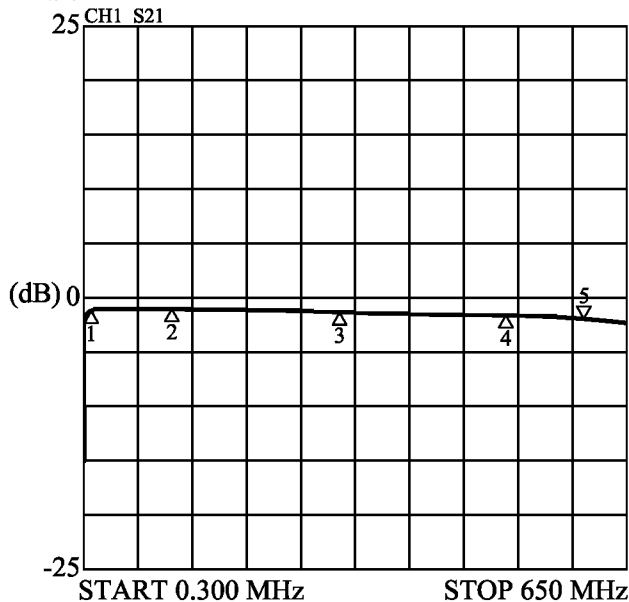

- ① -1.5025 dB / 3.5 MHz
- ② -1.0559 dB / 100 MHz
- ③ -1.6585 dB / 300 MHz
- ④ -1.8729 dB / 500 MHz
- ⑤ -2.6648 dB / 600 MHz

SC60360008

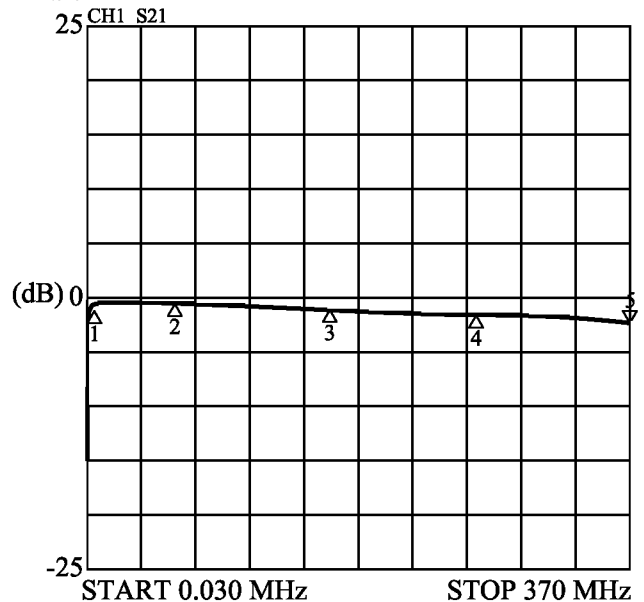

- ① -0.9201 dB / 2.0 MHz
- ② -0.7547 dB / 50 MHz
- ③ -1.2114 dB / 200 MHz
- ④ -1.4764 dB / 300 MHz
- ⑤ -2.6306 dB / 370 MHz

AR-001A

SPECIFICATION FOR APPROVAL

REF :

PAGE: 9

PROD. NAME	SMD BALUN TRANSFORMER	ABC'S DWG NO. ABC'S ITEM NO.	SC6036□□□□L□-□□□
---------------	-----------------------	---------------------------------	------------------

SC60360009

25 CH1 S21

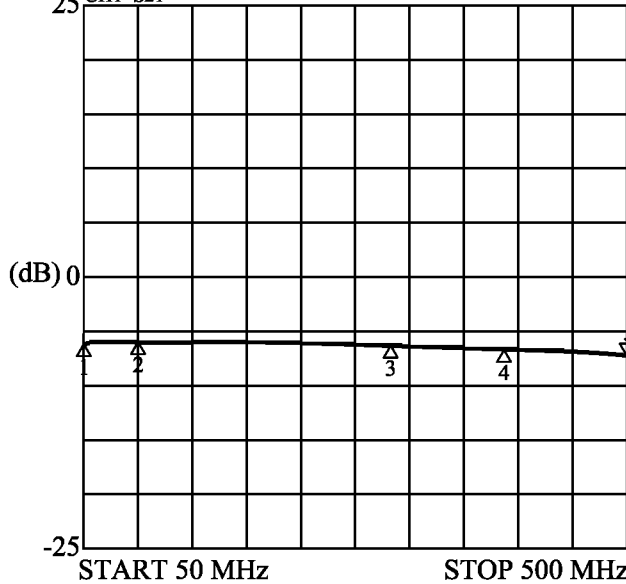

- ① -5.5958 dB / 100 MHz
- ② -5.4408 dB / 200 MHz
- ③ -5.7216 dB / 300 MHz
- ④ -6.1968 dB / 400 MHz
- ⑤ -6.7560 dB / 500 MHz

SC60360010

25 CH1 S21

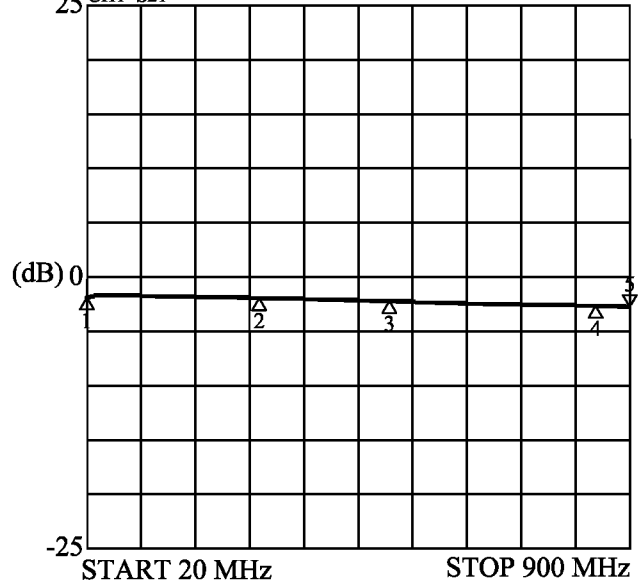

- ① -2.3639 dB / 20 MHz
- ② -2.2582 dB / 300 MHz
- ③ -2.7474 dB / 500 MHz
- ④ -2.8191 dB / 850 MHz
- ⑤ -2.9807 dB / 900 MHz

SC60360011

25 CH1 S21

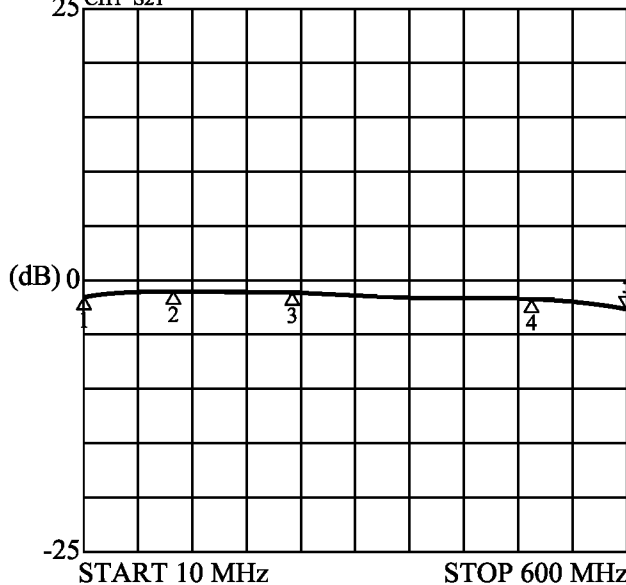

- ① -2.1772 dB / 10 MHz
- ② -1.0075 dB / 100 MHz
- ③ -1.3128 dB / 240 MHz
- ④ -1.4888 dB / 500 MHz
- ⑤ -2.5401 dB / 600 MHz

SC60360012

25 CH2 S21

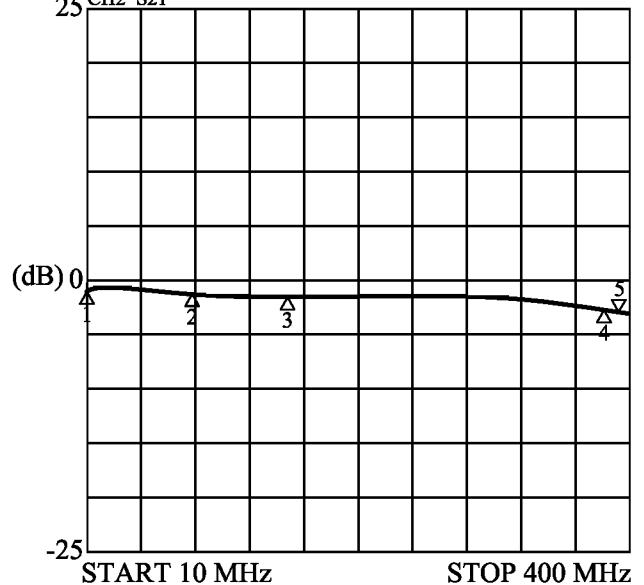

- ① -1.0194 dB / 10 MHz
- ② -1.0368 dB / 85 MHz
- ③ -1.4030 dB / 150 MHz
- ④ -2.6303 dB / 380 MHz
- ⑤ -2.9904 dB / 390 MHz

AR-001A

SPECIFICATION FOR APPROVAL

REF :

PAGE: 10

PROD. NAME	SMD BALUN TRANSFORMER	ABC'S DWG NO. ABC'S ITEM NO.	SC6036□□□□L□-□□□
---------------	-----------------------	---------------------------------	------------------

SC60360013

25 CH1 S21

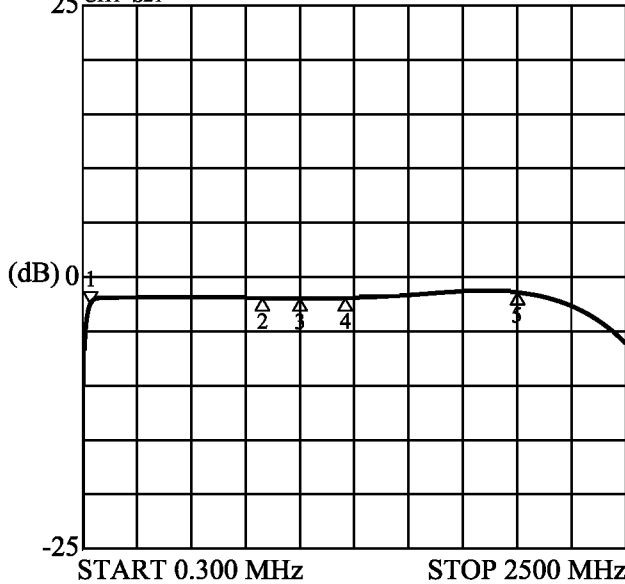

- ① -2.4058 dB / 10 MHz
- ② -2.4434 dB / 850 MHz
- ③ -2.5636 dB / 1000 MHz
- ④ -2.5226 dB / 1200 MHz
- ⑤ -1.3914 dB / 2000 MHz

SC60360014

25 CH1 S21

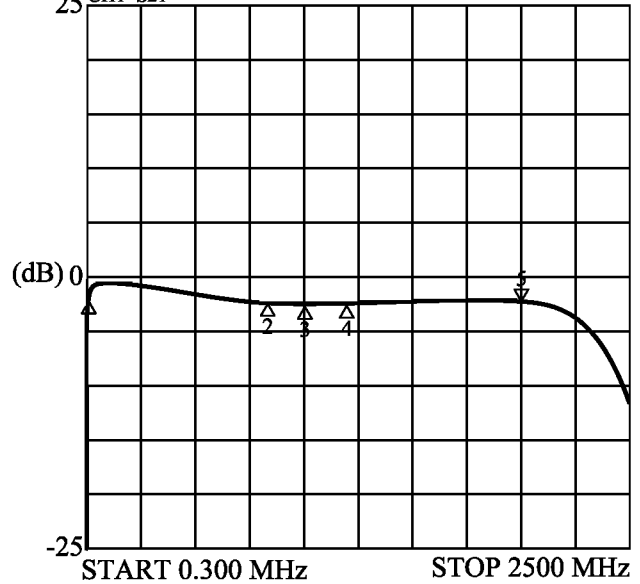

- ① -2.4797 dB / 6.0 MHz
- ② -2.8448 dB / 850 MHz
- ③ -2.8760 dB / 1000 MHz
- ④ -2.6107 dB / 1200 MHz
- ⑤ -2.8353 dB / 2000 MHz

SC60360015

25 CH1 S21

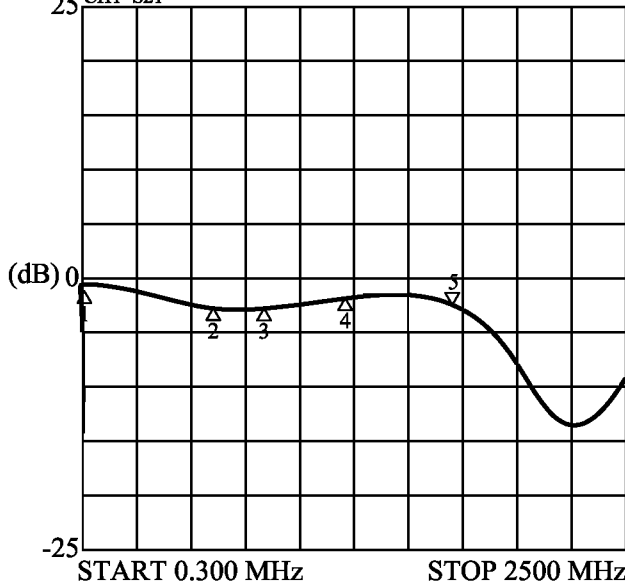

- ① -1.5440 dB / 6.0 MHz
- ② -2.5877 dB / 600 MHz
- ③ -2.8402 dB / 850 MHz
- ④ -1.8911 dB / 1200 MHz
- ⑤ -2.8265 dB / 1700 MHz

SC60360016

25 CH2 S21

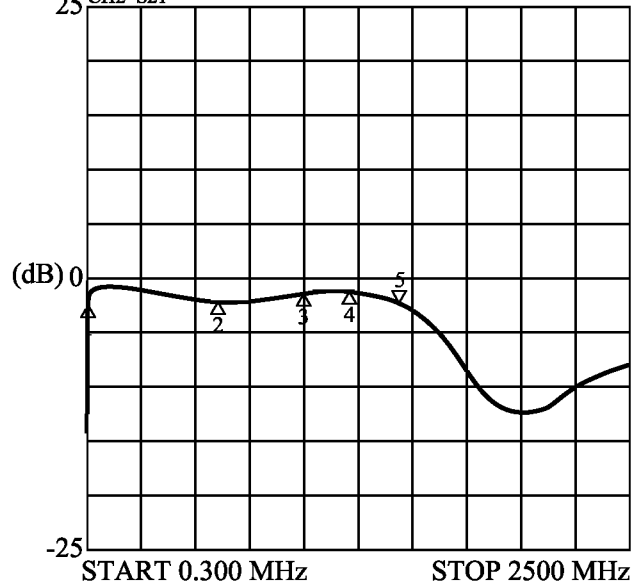

- ① -2.6800 dB / 5.0 MHz
- ② -2.3717 dB / 600 MHz
- ③ -1.7034 dB / 1000 MHz
- ④ -1.4836 dB / 1200 MHz
- ⑤ -2.5552 dB / 1400 MHz

AR-001A

SPECIFICATION FOR APPROVAL

REF :

PAGE: 11

PROD. NAME	SMD BALUN TRANSFORMER	ABC'S DWG NO. ABC'S ITEM NO.	SC6036□□□□L□-□□□
---------------	-----------------------	---------------------------------	------------------

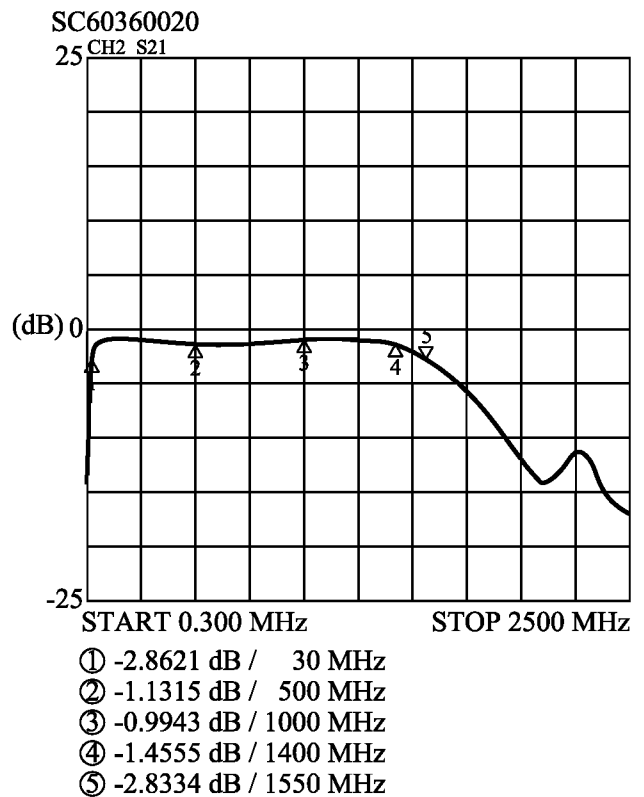
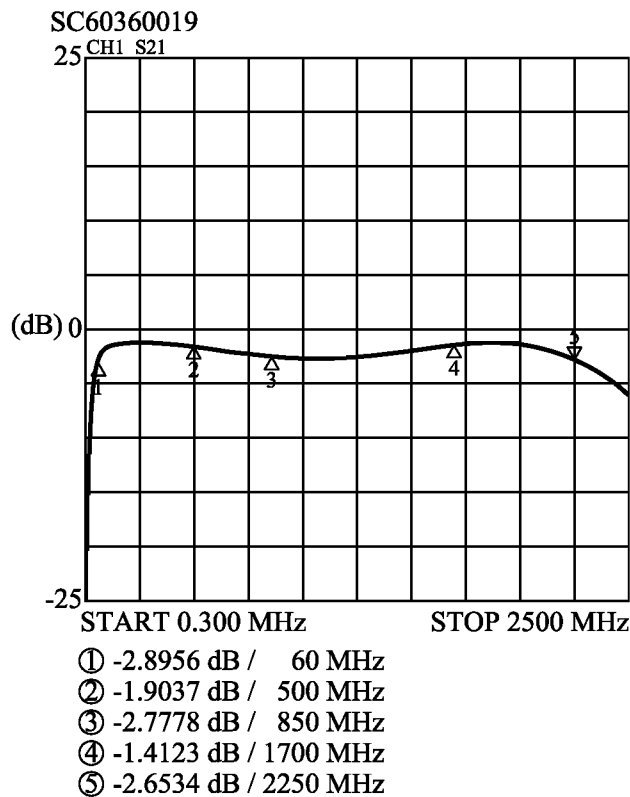
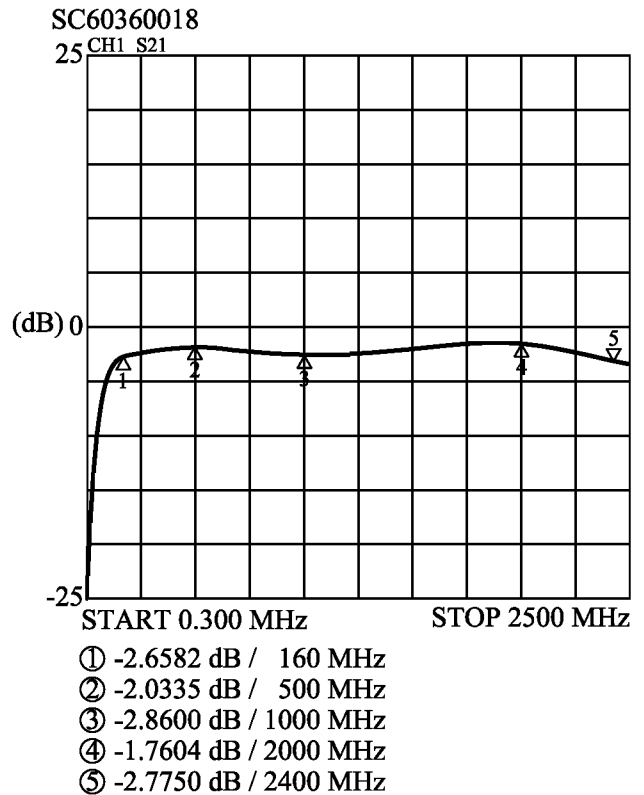
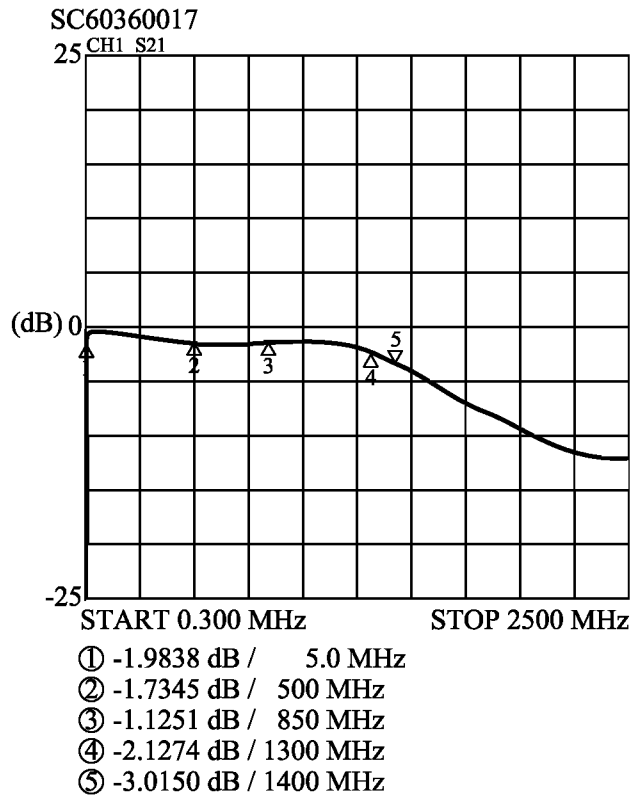

AR-001A