

# SSM SERIES

Miniature micro switches, detector switches up to 30vdc  
SPDT, all PBT body and PCB terminals

## Features

Rating: 30VDC, 500mA  
Initial contact resistance : 100m Ohm max.  
Insulation resistance : 100M min, at 250VDC  
Dielectric strength : 500 VAC for 1 minute  
Temperature range : -15 to +70 degrees in celsius  
Operating force: 50~120gf maximum  
Switch life: 100,000 cycles minimum

Housing: PBT  
Cover: PBT  
Lever: PBT  
Actuator: POM  
Contacts: Silver alloy  
Terminals: Brass, silver plated

## SSM-001

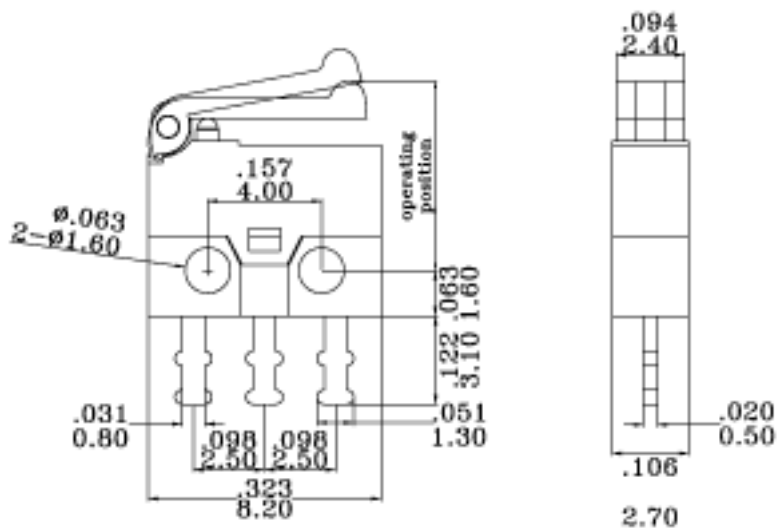
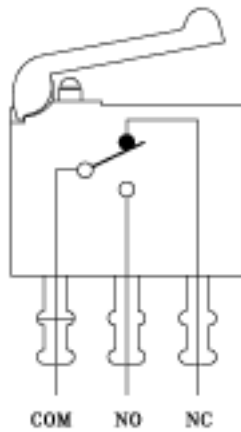

## SSM-001R

*With Lever & Right-Angled Terminals*

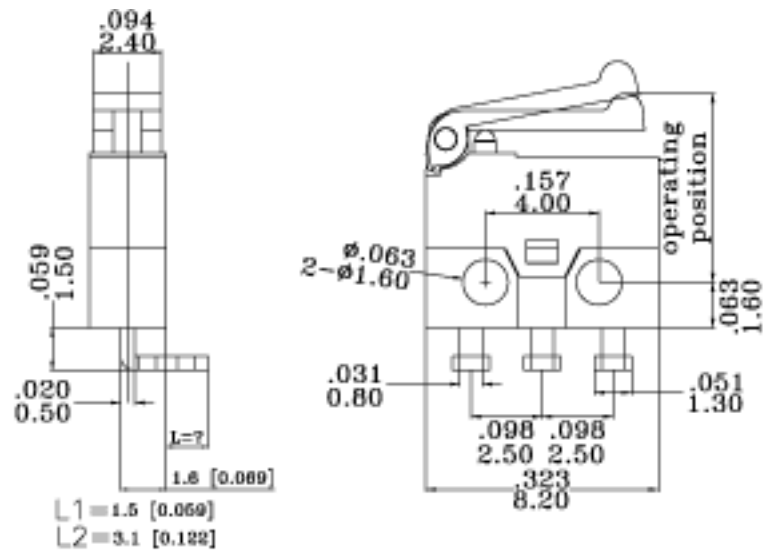
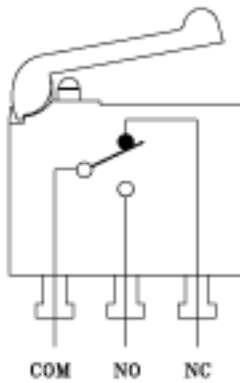

### SSM-002



FP: 6.2 mm(MAX)  
 OP: 5.6 ± 0.15mm  
 RP: 5.75 (MAX)  
 OT: 5.45 (MIN)

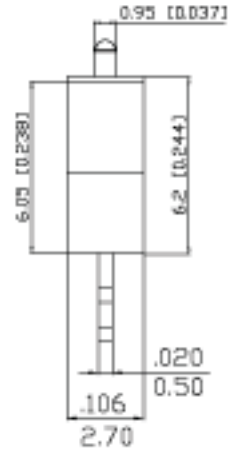
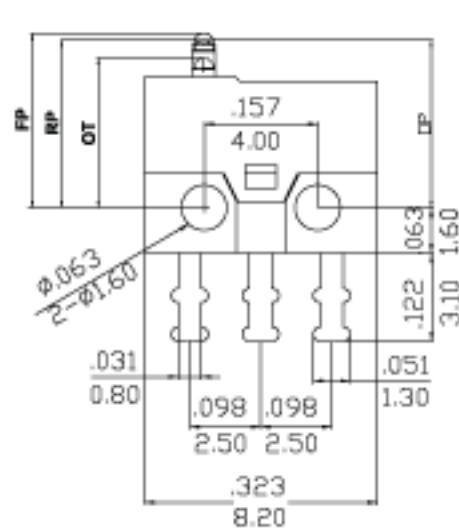
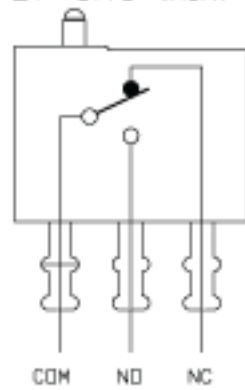

### SSM-003

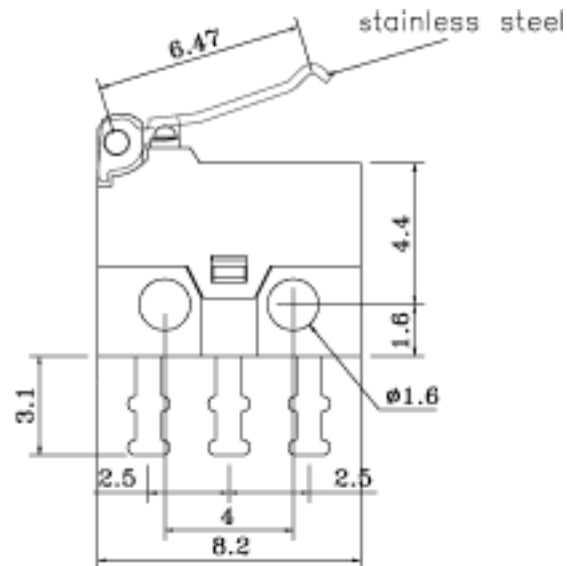
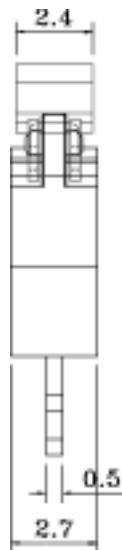

### SSM-004

