

# WSxxP6SMB(-B) Series

## Transient Voltage Suppressor

### Features

- 600 watts Peak Pulse Power (10/1000  $\mu$ s)
- Unidirectional and Bidirectional Protection
- Fast Response Time : Typically < 1ps
- Excellent Clamping Capability
- Glass Passivated Junction
- Built-in Strain relief
- Low inductance
- Low profile package
- High temperature solder:260°C/20 seconds at terminal

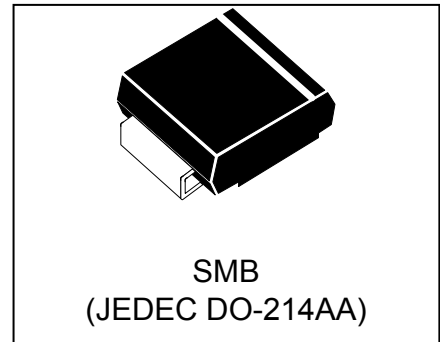

### Mechanical Characteristics

- JEDEC DO-214AA(SMBJ) package
- Molding compound flammability rating: UL 94V-0
- Marking : Marking Code
- Packaging : Tape and Reel per EIA 481
- RoHS/WEEE Compliant

### Applications

- I/O Interfaces
- Power lines
- Automotive and Telecommunication
- Computers & Consumer Electronics
- Industrial Electronics

Absolute Maximum Rating			
Rating	Symbol	Value	Units
Peak Pulse Power ( $t_p = 10/1000\mu s$ ) (see Note1,2& 3)	$P_{PPM}$	600	Watts
Peak pulse current (10/1000 $\mu$ s) (see Note2&3)	$I_{PPM}$	See Electrical Characteristics	A
Peak Forward surge current (see Note4&5)	$I_{FSM}$	100	A
Power Dissipation on infinite heat sink $T_A = 50^\circ C$ (Fig5)	$P_D$	5.0	W
Operating Junction Temperature range	$T_J$	-65 to + 150	$^\circ C$
Storage Temperature range	$T_{STG}$	-65 to + 150	$^\circ C$

**Note1:** Peak Pulse Power Rating as Pulse Width ,per Fig1.

**Note2:** Peak Pusle Power or Current Derated above  $T_A=25^\circ C$  Per Fig. 2 and Non-Repetitive Current Pulse,Per Fig.3.

**Note3:** Mounted on 5.0x5.0mm<sup>2</sup> copper pad to each terminal.

**Note4:** 8.3ms Single Half Sine Wave or Equivalent Square Wave.

**Note5:** Maximum Forward Surge Current only for Unidirectional Device per Fig6.

## Electrical Characteristics

Part Number		Reverse Stand off Voltage $V_{RWM}$ (Volts)	Breakdown Voltage $V_{BR}(\text{Volts})@I_T$		Test Current $I_T$ (mA)	Maximum Clamping Voltage $V_C@I_{PP}$ (Volts)	Maximum Peak Pulse Current $I_{PP}$ (Amps)	Maximum Reverse Leakage $I_R@V_{RWM}$ ( $\mu$ A)
			MIN	MAX				
UNI-POLAR	BI-POLAR							
WS5.0P6SMB	WS5.0P6SMB-B	5.0	6.40	7.07	10	9.2	65.2	800
WS6.0P6SMB	WS6.0P6SMB-B	6.0	6.67	7.37	10	10.3	58.3	800
WS6.5P6SMB	WS6.5P6SMB-B	6.5	7.22	7.98	10	11.2	53.6	500
WS7.0P6SMB	WS7.0P6SMB-B	7.0	7.78	8.60	10	12.0	50.0	200
WS7.5P6SMB	WS7.5P6SMB-B	7.5	8.33	9.21	1	12.9	46.5	100
WS8.0P6SMB	WS8.0P6SMB-B	8.0	8.89	9.83	1	13.6	44.1	50
WS8.5P6SMB	WS8.5P6SMB-B	8.5	9.44	10.40	1	14.4	41.7	20
WS9.0P6SMB	WS9.0P6SMB-B	9.0	10.00	11.10	1	15.4	39.0	10
WS10P6SMB	WS10P6SMB-B	10	11.10	12.30	1	17.0	35.3	5
WS11P6SMB	WS11P6SMB-B	11	12.20	13.50	1	18.2	33.0	5
WS12P6SMB	WS12P6SMB-B	12	13.30	14.7	1	19.9	30.2	5
WS13P6SMB	WS13P6SMB-B	13	14.40	15.90	1	21.5	27.9	1
WS14P6SMB	WS14P6SMB-B	14	15.60	17.20	1	23.2	25.9	1
WS15P6SMB	WS15P6SMB-B	15	16.70	18.50	1	24.4	24.6	1
WS16P6SMB	WS16P6SMB-B	16	17.80	19.70	1	26.0	23.1	1
WS17P6SMB	WS17P6SMB-B	17	18.90	20.90	1	27.6	21.7	1
WS18P6SMB	WS18P6SMB-B	18	20.00	22.10	1	29.2	20.5	1
WS20P6SMB	WS20P6SMB-B	20	22.20	24.50	1	32.4	18.5	1
WS22P6SMB	WS22P6SMB-B	22	24.40	26.90	1	35.5	16.9	1
WS24P6SMB	WS24P6SMB-B	24	26.70	29.50	1	38.9	15.4	1
WS26P6SMB	WS26P6SMB-B	26	28.90	31.90	1	42.1	14.3	1
WS28P6SMB	WS28P6SMB-B	28	31.10	34.40	1	45.4	13.2	1
WS30P6SMB	WS30P6SMB-B	30	33.30	36.80	1	48.4	12.4	1
WS33P6SMB	WS33P6SMB-B	33	36.70	40.60	1	53.3	11.3	1
WS36P6SMB	WS36P6SMB-B	36	40.00	44.20	1	58.1	10.3	1
WS40P6SMB	WS40P6SMB-B	40	44.40	49.10	1	64.5	9.3	1
WS43P6SMB	WS43P6SMB-B	43	47.80	52.80	1	69.4	8.6	1

## Electrical Characteristics (Cont.)

Part Number		Reverse Stand off Voltage $V_{RWM}$ (Volts)	Breakdown Voltage $V_{BR}(\text{Volts})@I_T$		Test Current $I_T$ (mA)	Maximum Clamping Voltage $V_C@I_{PP}$ (Volts)	Maximum Peak Pulse Current $I_{pp}$ (Amps)	Maximum Reverse Leakage $I_R@V_{RWM}$ ( $\mu A$ )
			MIN	MAX				
UNI-POLAR	BI-POLAR							
WS45P6SMB	WS45P6SMB-B	45	50.00	55.30	1	72.7	8.3	1
WS48P6SMB	WS48P6SMB-B	48	53.30	58.90	1	77.4	7.8	1
WS51P6SMB	WS51P6SMB-B	51	56.70	62.70	1	82.4	7.3	1
WS54P6SMB	WS54P6SMB-B	54	60.00	66.30	1	87.1	6.9	1
WS58P6SMB	WS58P6SMB-B	58	64.40	71.20	1	93.6	6.4	1
WS60P6SMB	WS60P6SMB-B	60	66.70	73.70	1	96.8	6.2	1
WS64P6SMB	WS64P6SMB-B	64	71.10	78.60	1	103	5.8	1
WS70P6SMB	WS70P6SMB-B	70	77.80	86.00	1	113	5.3	1
WS75P6SMB	WS75P6SMB-B	75	83.30	92.10	1	121	5.0	1
WS78P6SMB	WS78P6SMB-B	78	86.70	95.80	1	126	4.8	1
WS85P6SMB	WS85P6SMB-B	85	94.40	104	1	137	4.4	1
WS90P6SMB	WS90P6SMB-B	90	100	111	1	146	4.1	1
WS100P6SMB	WS100P6SMB-B	100	111	123	1	162	3.7	1
WS110P6SMB	WS110P6SMB-B	110	122	135	1	177	3.4	1
WS120P6SMB	WS120P6SMB-B	120	133	147	1	193	3.1	1
WS130P6SMB	WS130P6SMB-B	130	144	159	1	209	2.9	1
WS150P6SMB	WS150P6SMB-B	150	167	185	1	243	2.5	1
WS160P6SMB	WS160P6SMB-B	160	178	197	1	259	2.3	1
WS170P6SMB	WS170P6SMB-B	170	189	209	1	275	2.2	1
WS180P6SMB	WS180P6SMB-B	180	201	222	1	292	2.1	1
WS200P6SMB	WS200P6SMB-B	200	224	247	1	324	1.9	1
WS220P6SMB	WS220P6SMB-B	220	246	272	1	356	1.7	1
WS250P6SMB	WS250P6SMB-B	250	279	309	1	405	1.5	1
WS300P6SMB	WS300P6SMB-B	300	335	371	1	486	1.3	1
WS350P6SMB	WS350P6SMB-B	350	391	432	1	567	1.1	1
WS400P6SMB	WS400P6SMB-B	400	447	494	1	648	0.9	1
WS440P6SMB	WS440P6SMB-B	440	492	543	1	713	0.9	1

## Typical Characteristics

Figure 1: Peak Pulse Power Rating Curve

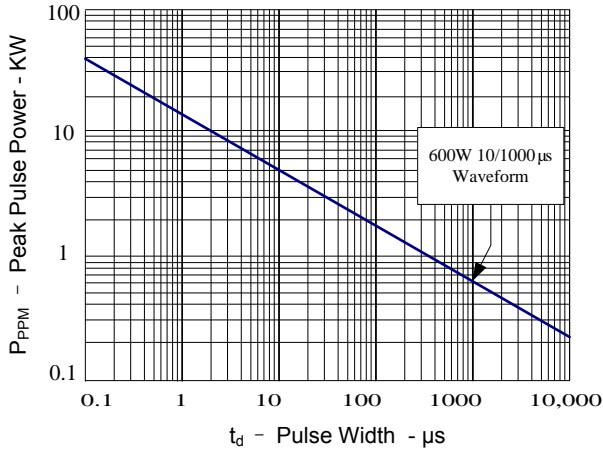

Figure 2: Pulse Derating Curve

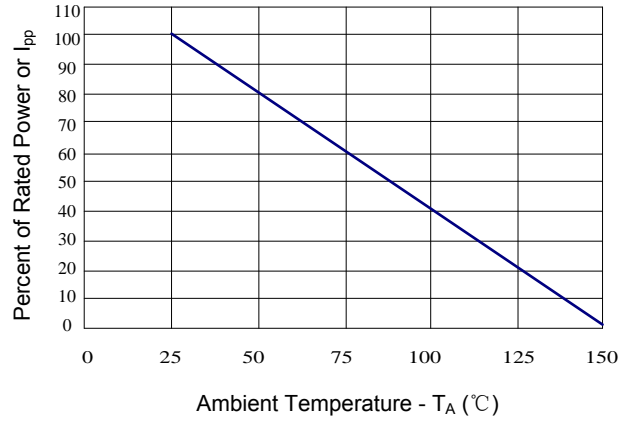

Figure 3: Pulse Waveform

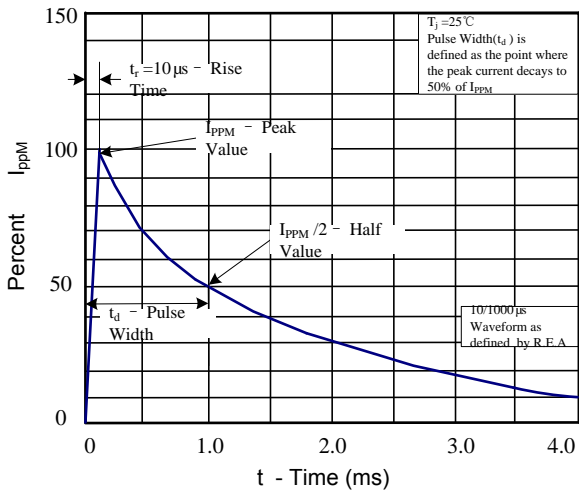

Figure 4: Typical Junction Capacitance

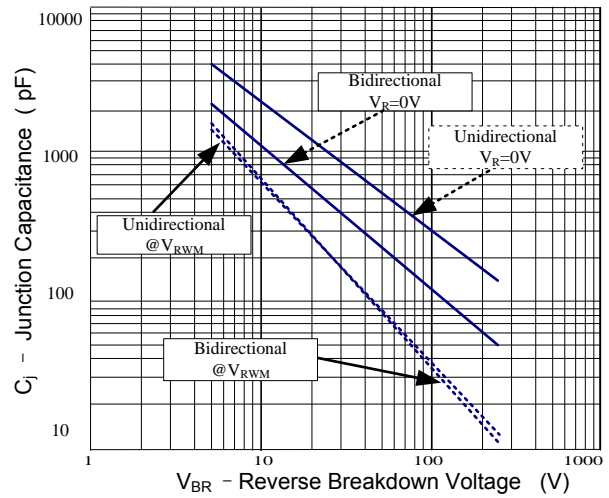

Figure 5: Steady State Power Dissipation Derating Curve

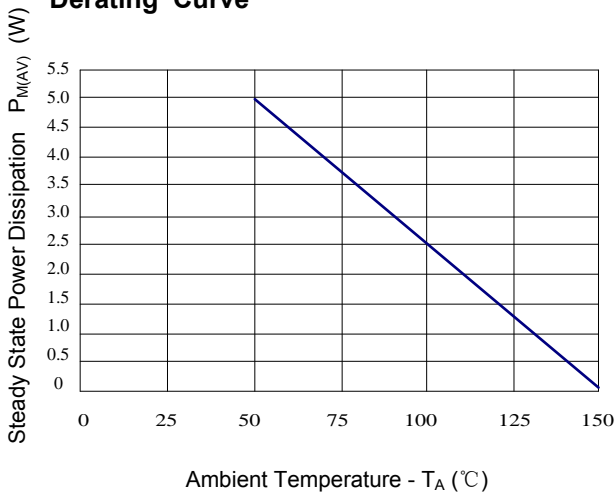
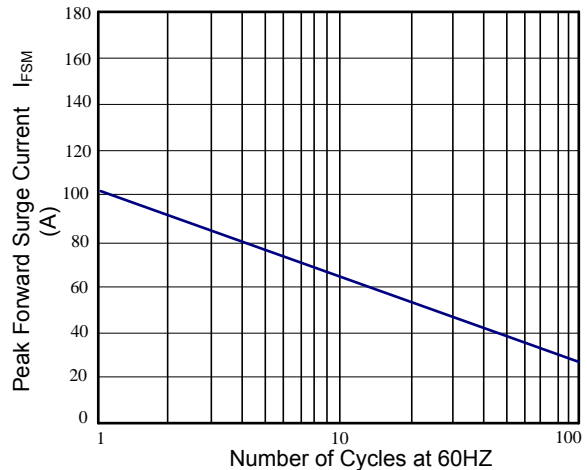

Figure 6: Maximum Non-Repetitive Forward Surge Current Only Unidirectional



**Outline Drawing – SMBJ(DO-214AA)**

Ref. (mm)	Millimeters	
	Min.	Max.
A	2.130	2.440
A1	-	0.203
B	1.950	2.200
E	4.060	4.570
E1	0.152	0.305
D	3.300	3.940
L	0.760	1.520

