



- * Product Name: Rocker Switch;
- * Model No: YSR-12 (B)
- * Voltage Resistance: 2000VAC, 1MIN;
- * Operating Temperature: T85 T105
- * Electrical Life: more than 50,000cycles
- * Contact Rating: UL、CUL: 3/6A 250/125VAC, 5/10A 250/125VAC
 6.5/13A 250/125VAC, 10/15A 250/125VAC
 16A 250/125VAC, 1/3HP 125VAC
 VDE: 3 (1) A 250V ~, 6 (2) A 250V ~
 10 (4) A 250V ~



KNOB COLOR	BLACK; RED; GREEN; ORANGE; BLUE; ...
BASE COLOR	GRAY; BLACK; WHITE; ...
KNOB SHAPE	TYPE C: 
Unilluminate	YSR-12-21 (B) 2P1T 4P, YSR-12-11 (B) 1P1T 2P

Wiring Diagram

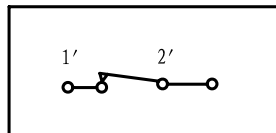

YSR-12-11 (B)
On-Off (Unilluminate)

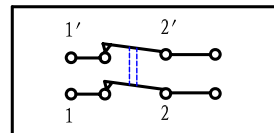

YSR-12-21 (B)
On-Off (Unilluminate)

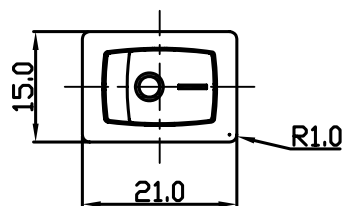
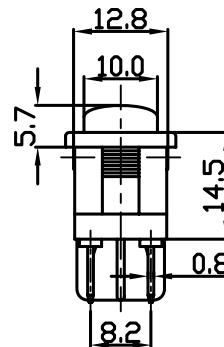
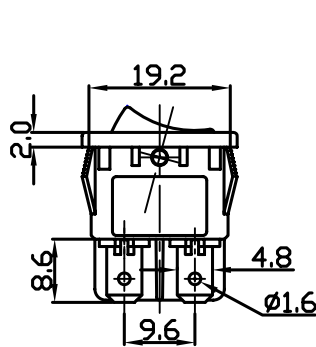

Panel Installation Size

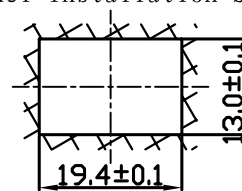

Panel Installation
Thickness 1 ~ 4mm