



- * Product Name: Rocker Switch;
- * Model No: YSR-15 (5)
- * Voltage Resistance: 2000VAC, 1MIN;
- * Operating Temperature: T85
- * Electrical Life: more than 10,000cycles
- * Contact Rating: UL CUL: 16/20A 250/125VAC, 1HP 125VAC



KNOB COLOR	BLACK; RED; GREEN; ORANGE; BLUE; ...
BASE COLOR	GRAY; BLACK; WHITE; ...
KNOB SHAPE	TYPE C: 
Unilluminate	YSR-15-11 (5) 1P1T 2P, YSR-15-12 (5) 1P2T 3P, YSR-15-13 (5) 1P2T 3P

Wiring Diagram

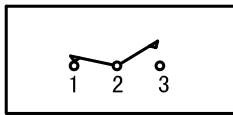

YSR-15-12 (5)

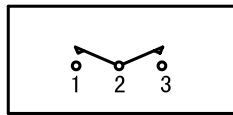

YSR-15-13 (5)

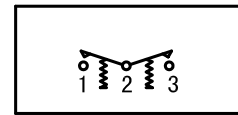

YSR-15-13 (5)

On-On (Unilluminate) On-Off-On (Unilluminate) (On)-Off-(On) (Unilluminate)

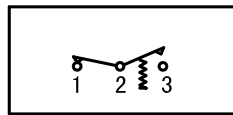

YSR-15-12 (5)

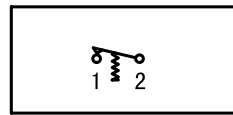

YSR-15-11 (5)

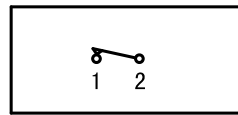

YSR-15-11 (5)

On-(On) (Unilluminate) (On)-Off (Unilluminate) On-Off (Unilluminate)

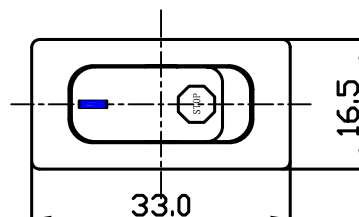
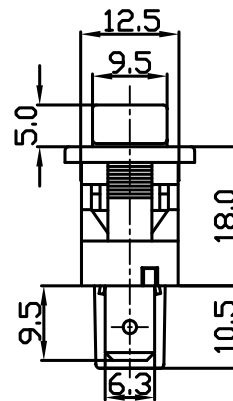
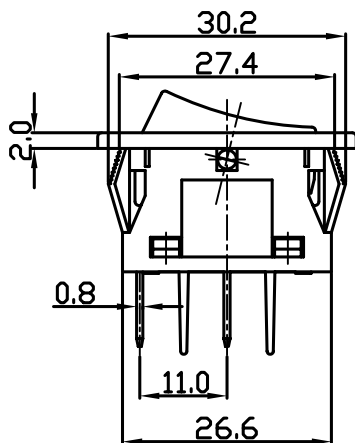

Panel Installation Size

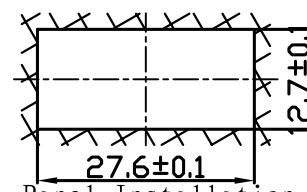

Panel Installation Thickness 1 ~ 4mm