



- * Product Name: Rocker Switch;
- * Model No: YSR-22 (-21, -22, -23)
- * Voltage Resistance: 2000VAC, 1MIN;
- * Operating Temperature: T105
- * Electrical Life: more than 10,000cycles
- * Contact Rating: UL CUL: 3/6A 250/125VAC, 5/10A 250/125VAC
6.5/13A 250/125VAC, 10/15A 250/125VAC 1/3HP
16A 250/125VAC, 1/2HP 125VAC



KNOB COLOR	BLACK; RED; GREEN; ORANGE; BLUE; ...
BASE COLOR	GRAY; BLACK; WHITE; ...
KNOB SHAPE	TYPE C: 
Unilluminate	YSR-22-23 2P2T 6P, YSR-22-22 2P2T 6P, YSR-22-21 2P1T 4P

Wiring Diagram

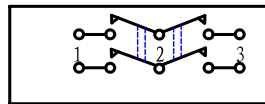

YSR-22-23

On-Off-On (Unilluminate)

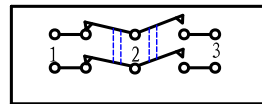

YSR-22-22

On-On (Unilluminate)

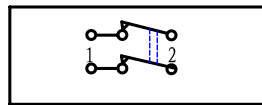

YSR-22-21

On-Off (Unilluminate)

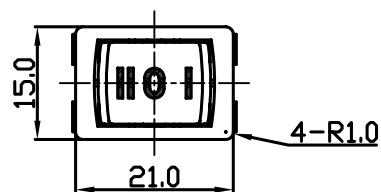
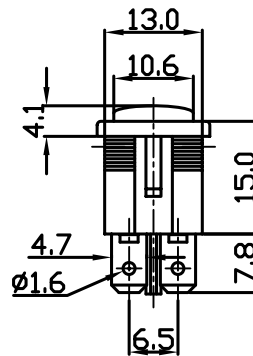
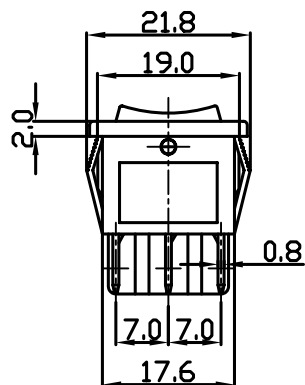

Panel Installation Size

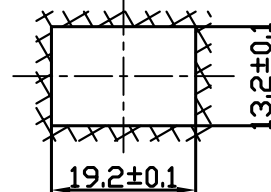

Panel Installation Thickness 1 ~ 4mm