





- * Product Name: Rocker Switch;
- * Model No: YSR-9
- * Voltage Resistance: 2000VAC, 1MIN;
- * Operating Temperature: T85
- * Electrical Life: more than 10,000cycles
- * Contact Rating: UL CUL: 16/20A 250/125VAC 1HP
VDE: 16A 250V ~



KNOB COLOR	BLACK; RED; GREEN; ORANGE; BLUE; ...		
BASE COLOR	GRAY; BLACK; WHITE; ...		
KNOB SHAPE	TYPE B: 	TYPE C: 	
Illuminate	YSR-9-11/N 1P1T 3P	Unilluminate	YSR-9-11 1P1T 2P

Wiring Diagram

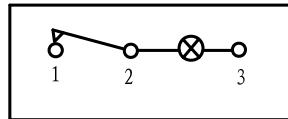

YSR-9-11/N
On-Off
(Illuminate)

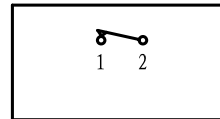

YSR-9-11
On-Off
(Unilluminate)

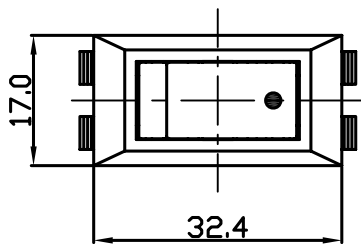
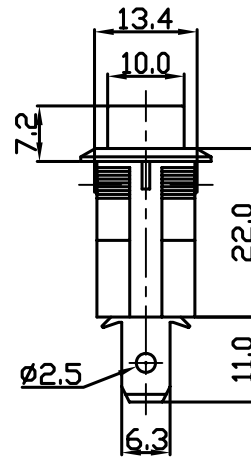
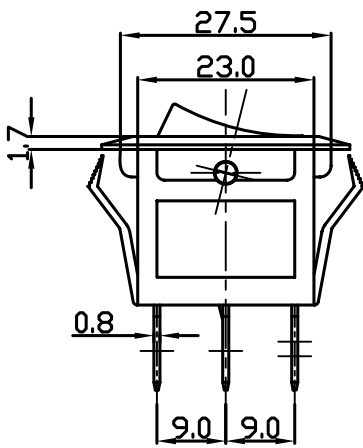

Panel Installation Size

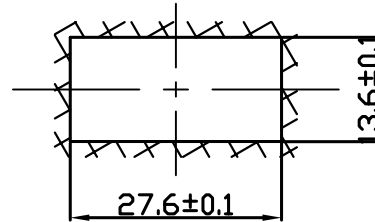

Panel Installation
Thickness 1 ~ 4mm